

COUPE DE FRANCE DES RALLYES PEA COEF. 3

FFSA

39EME RALLYE DU NOUGAT

DE MONTELMAR DROME PROVENCAL

17EME VHC 14EME VHRS 4EME VMRS

**ROAD-BOOK
VHRS ET VMRS**



29 ET 30 MAI 2026



Kms	Liaison	11 - ES	ITINÉRAIRE		H.Théorique	H.Théorique
386,576	267,835	118,741			Première	Dernière

VENDREDI 29 mai 2026 1ère Etape MONTELMAR / MONTELMAR VHC - Moderne

Postes	Routes	Imparti			Moyenne	
4,105	Secteur 1	00 H 10	MONTELMAR - MONTELMAR		24,6 Kh	
0,0	CH 0		Sortie Parc Palais des Congrès 1er VHC		19 H 15	21 H 35
4,105	CH 0a	VO	00 H 10	Entrée Parc Assistance Autajon S-P	19 H 25	21 H 45
PARC ASSISTANCE MONTELMAR						
15,300	Secteur 2	00 H 25	MONTELMAR - ROCHEFORT EN VALDAINE		36,7 Kh	
0,0	CH 0b	VO	Sortie Parc Assistance Autajon Santé		19 H 45	22 H 05
15,300	CH 1	D 127	00 H 25	Rochefort en Valdaïne	20 H 10	22 H 30
14,200	Secteur 3	00 H 20	ROCHEFORT EN VALDAINE - SALLES sous BOIS		42,6 Kh	
0,0	DES 1	D 127	00 H 03	DES Epreuve Rochefort en Valdaïne - "JP Tacussel"	20 H 13	22 H 33
12,350	AES 1	D 24	AES Epreuve Rochefort en Valdaïne - "JP Tacussel"			
14,200	CH 2	VO	00 H 20	Salles sous Bois	20 H 33	22 H 53
32,400	Secteur 4	00 H 50	SALLES SOUS BOIS - MONTELMAR		38,8 Kh	
0,0	DES 2	VO	00 H 03	DES Epreuve Salles sous Bois Aleyrac "Notre dame la Brune"	20 H 36	22 H 56
8,099	AES 2	D 809	AES Epreuve Salles sous Bois Aleyrac "Notre dame la Brune"			
32,400	CH 2a		00 H 50	Entrée parc Montélimar Palais des Congrès fin 1ère étape	21 H 26	23 H 46

1ère ETAPE 1ère SECTION

SAMEDI 30 mai 2026 2ème ETAPE MONTELMAR / MONTELMAR VHRS - VMRS - VHC - Moderne

Postes	Routes	Imparti			Moyenne	
4,105	Secteur 5	00 H 10	MONTELMAR - MONTELMAR		24,6 Kh	
0,0	CH 2b		Sortie Parc Palais des Congrès 1er VHRS		07 H 30	10 H 45
4,105	CH 2c	VO	00 H 10	Entrée Parc Entrée Parc Assistance Autajon S-P	07 H 40	10 H 55
PARC ASSISTANCE MONTELMAR						
30,546	Secteur 6	00 H 40	MONTELMAR - SALLES sous BOIS		45,8 Kh	
0,0	CH 2d	VO	Sortie Parc Assistance Autajon Santé		08 H 25	11 H 40
30,546	CH 3	VO	00 H 40	Salles sous bois	09 H 05	12 H 20
13,759	Secteur 7	00 H 20	SALLES sous BOIS - SALLES sous BOIS		41,2 Kh	
0,0	DES 3	D VO	00 H 03	DES Epreuve Salles sous Bois Aleyrac "Notre dame la Brune"	09 H 08	12 H 23
8,099	AES 3	D 809	AES Epreuve Salles sous Bois Aleyrac "Notre dame la Brune"			
13,759	CH 4	D V24	00 H 20	Salles sous Bois	09 H 28	12 H 43
31,888	Secteur 8	00 H 40	SALLES sous BOIS - MONTSEGUR sur LAUZON		47,8 Kh	
0,0	DES 4	D 24	00 H 03	Départ Epreuve Le Colombier "Citelles"	09 H 31	12 H 46
13,376	AES 4	D 4	Arrivée Epreuve Le Colombier "Citelles"			
31,888	CH 5	D 481	00 H 40	Montsegur sur Lauzon	10 H 11	13 H 26
38,411	Secteur 9	00 H 45	MONTSEGUR sur LAUZON - MONTELMAR		51,2 Kh	
0,000	DES 5	D 481	00 H 03	DES Epreuve Montségur/Lauzon " Bassin des Druides"	10 H 14	13 H 29
11,289	AES 5	D 471	AES Epreuve Montségur/Lauzon " Bassin des Druides"			
38,411	CH 5a		00 H 45	Entrée Parc Regroupement Palais des Congrès Montélimar	10 H 59	14 H 14
PARC REGROUPEMENT MONTELMAR						

2ème ETAPE 2ème SECTION

SAMEDI 30 mai 2026 2ème ETAPE MONTELMAR / MONTELMAR VHRS - VMRS - VHC - Moderne

Postes	Routes	Imparti			Moyenne	
4,105	Secteur 10	00 H 10	MONTELMAR - MONTELMAR		24,6 Kh	
0,0	CH 5b		Sortie Parc Regroupement Palais des Congrès 1er VHRS		11 H 59	15 H 14
4,105	CH 5c	VO	00 H 10	Entrée Parc Entrée Parc Assistance Autajon S-P	12 H 09	15 H 24
PARC ASSISTANCE MONTELMAR						
30,546	Secteur 11	00 H 40	MONTELMAR - SALLES sous BOIS		45,8 Kh	
0,0	CH 5d	VO	Sortie Parc Assistance Autajon Santé		12 H 49	16 H 04
30,546	CH 6	VO	00 H 40	Salles sous bois	13 H 29	16 H 44
14,200	Secteur 12	00 H 20	SALLES sous BOIS - SALLES sous BOIS		41,2 Kh	
0,0	DES 6	VO	00 H 03	DES Epreuve Salles sous Bois Aleyrac "Notre dame la Brune"	13 H 32	16 H 47
8,099	AES 6	D 809	AES Epreuve Salles sous Bois Aleyrac "Notre dame la Brune"			
14,200	CH 7	D 24	00 H 20	Salles sous Bois	13 H 52	17 H 07
27,850	Secteur 13	00 H 40	SALLES sous BOIS - MONTSEGUR sur LAUZON		47,8 Kh	
0,0	DES 7	D 24	00 H 03	Départ Epreuve Le Colombier "Citelles"	13 H 55	17 H 10
13,376	AES 7	D 4	Arrivée Epreuve Le Colombier "Citelles"			
31,888	CH 8	D 481	00 H 40	Montsegur sur Lauzon	14 H 35	17 H 50
38,411	Secteur 14	00 H 45	MONTSEGUR sur LAUZON - MONTELMAR		51,2 Kh	
0,000	DES 8	D 481	00 H 03	DES Epreuve Montségur/Lauzon " Bassin des Druides"	14 H 38	17 H 53
11,289	AES 8	D 471	AES Epreuve Montségur/Lauzon " Bassin des Druides"			
38,411	CH 8a		00 H 45	Entrée Parc Regroupement Palais des Congrès Montélimar	15 H 23	18 H 38
PARC REGROUPEMENT MONTELMAR						

2ème ETAPE 3ème SECTION

SAMEDI 30 mai 2026 2ème ETAPE MONTELMAR / MONTELMAR VHRS - VMRS - VHC - Moderne

Postes	Routes	Imparti			Moyenne	
4,105	Secteur 15	00 H 10	MONTELMAR - MONTELMAR		24,6 Kh	
0,0	CH 8b		Sortie Parc Regroupement Palais des Congrès 1er VHRS		16 H 13	19 H 28
4,105	CH 8c	VO	00 H 10	Entrée Parc Entrée Parc Assistance Autajon S-P	16 H 23	19 H 38
PARC ASSISTANCE MONTELMAR						
30,546	Secteur 16	00 H 40	MONTELMAR - SALLES sous BOIS		45,8 Kh	
0,0	CH 8 d	VO	Sortie Parc Assistance Autajon Santé		17 H 03	20 H 18
30,546	CH 9	VO	00 H 40	Salles sous bois	17 H 43	20 H 58
14,200	Secteur 17	00 H 20	SALLES sous BOIS - SALLES sous BOIS		41,2 Kh	
0,0	DES 9	VO	00 H 03	DES Epreuve Salles sous Bois Aleyrac "Notre dame la Brune"	17 H 46	21 H 01
8,099	AES 9	D 809	AES Epreuve Salles sous Bois Aleyrac "Notre dame la Brune"			
14,200	CH 10	D 24	00 H 20	Salles sous Bois	18 H 06	21 H 21
31,888	Secteur 18	00 H 40	SALLES sous BOIS - MONTSEGUR sur LAUZON		47,8 Kh	
0,0	DES 10	D 24	00 H 03	Départ Epreuve Le Colombier "Citelles"	18 H 09	21 H 24
13,376	AES 10	D 4	Arrivée Epreuve Le Colombier "Citelles"			
31,888	CH 11	D 481	00 H 40	Montsegur sur Lauzon	18 H 49	22 H 04
38,411	Secteur 19	00 H 45	MONTSEGUR sur LAUZON - MONTELMAR		51,2 Kh	
0,000	DES 11	D 481	00 H 03	DES Epreuve Montségur/Lauzon " Bassin des Druides"	18 H 52	22 H 07
11,289	AES 11	D 471	AES Epreuve Montségur/Lauzon " Bassin des Druides"			
38,411	CH 11a		00 H 45	Entrée Parc Final Palais des Congrès Montélimar 1er VHRS	19 H 37	22 H 52

2ème ETAPE 4ème SECTION

**39ÈME RALLYE NATIONAL DU NOUGAT
DE MONTÉLIMAR DRÔME PROVENÇALE**

29 et 30 mai 2026

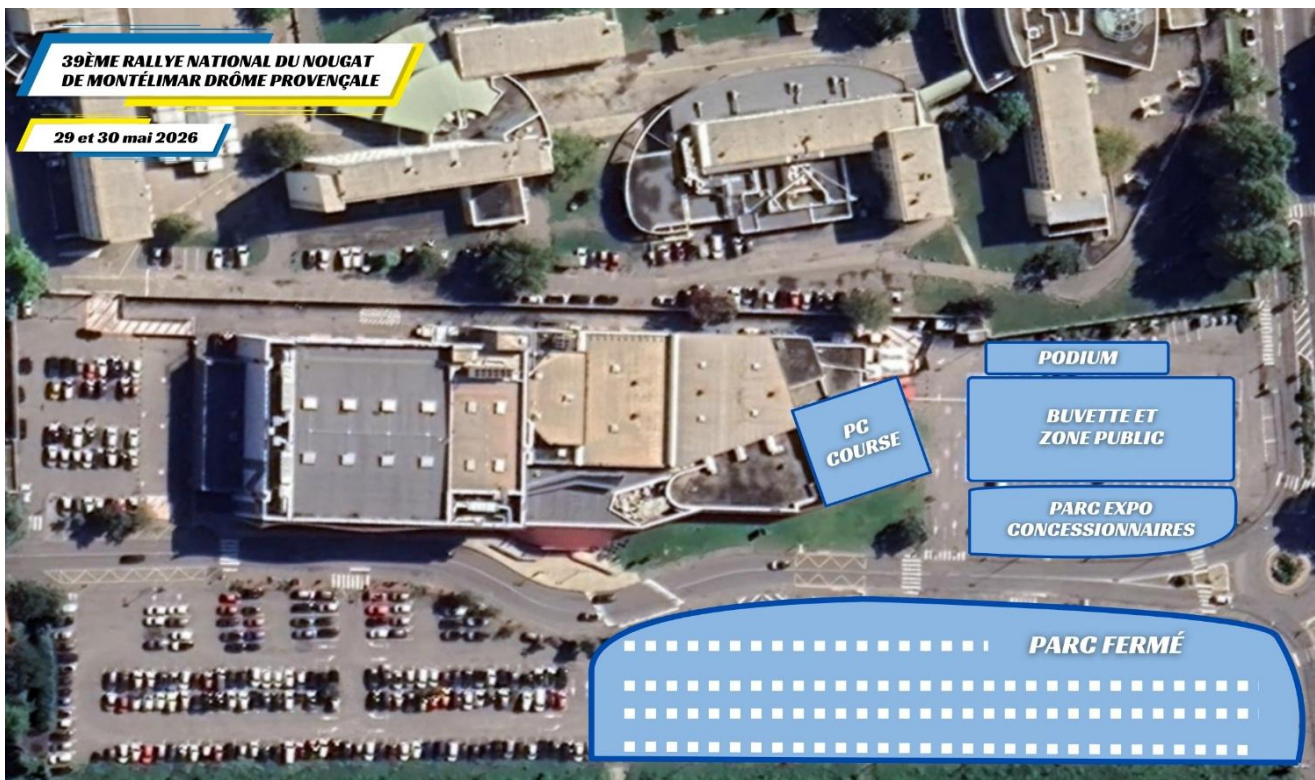

**39ÈME RALLYE NATIONAL DU NOUGAT
DE MONTÉLIMAR DRÔME PROVENÇALE**

29 et 30 mai 2026



IMPORTANT

Mesdames, Messieurs les concurrents,

C'est grâce à la compréhension des Riverains et des Municipalités des communes traversées par le Rallye que l'Association Sportive Automobile de Montélimar a pu organiser cette année les :

39^{ème} Rallye National du Nougat de Montélimar Drôme-Provençale
17^{ème} Rallye National V.H.C du Nougat de Montélimar Drôme-Provençale
14^{ème} Rallye National V.H.R.S du Nougat de Montélimar Drôme-Provençale
4^{ème} Rallye National VMRS du Nougat de Montélimar Drôme-Provençale

C'est cependant grâce à votre sportivité et par l'attitude responsable que vous adopterez lors des reconnaissances du parcours, que la pérennité de l'épreuve pourra être assurée.

Nous vous demandons de **RESPECTER LE CODE DE LA ROUTE**, afin de préserver, la sécurité et la tranquillité des populations et des villages qui vous accueillent, et de suivre scrupuleusement les limitations de vitesse et les horaires réglementés, sur des routes fréquentées par des enfants, allant ou revenant de l'école, et par des véhicules agricoles.

**EN ACCORD AVEC LES SERVICES PREFECTORAUX ET LA GENDARMERIE,
LA REGLEMENTATION SUIVANTE SERA APPLIQUEE :**

Reconnaisances strictement interdites avant le 25 mai 2026

Reconnaisances autorisées uniquement

Le lundi 25 mai 2026 de 9 h 00 à 18 h 30

Le vendredi 29 mai 2026 de 9 h 00 à 18 h 00

Parution du Road Book : www.asamontelimar.com : 21/05/2025

Distribution feuille de reco & panneau de porte : 25/05/2026 et 29/05/2026 8H30

Parking assistance (Autajon Santé Pharmacie à Montélimar)

De plus, dans tous les rallyes asphaltés, le nombre de passages en reconnaissances est limité à 3 au maximum (Art 6.2.1 France Auto 2026)

Limitations de vitesse : **50 Km/h sur les routes des épreuves spéciales.**
30 Km/h dans les agglomérations.

De nombreux contrôles (radars) seront effectués. En sus des procès-verbaux éventuels, des sanctions sportives pouvant aller jusqu'à la mise hors course (refus du départ) sanctionneront les contrevenants sans qu'ils puissent prétendre à un quelconque remboursement des droits d'engagement (conformément au règlement standard des Rallyes français - art 13)

Afin de limiter la gêne des riverains, il vous est demandé :

- ⇒ **De veiller à ce qu'aucune dégradation ne soit apportée à l'environnement, Tous repères, marques, panneaux sont rigoureusement interdits.**
- ⇒ **De ne pas remonter les épreuves spéciales en sens inverse.**

Nous comptons sur votre sportivité, votre **courtoisie** et votre **sens du civisme**.

De votre comportement responsable dépend l'avenir des Rallyes

Le comité d'organisation vous souhaite un agréable **Rallye du Nougat de Montélimar Drôme-Provençal**

MONTELMAR - MONTELMAR						
CH		DISTANCE	TEMPS		Section	Secteur
CH 2B	CH 2C	4,105	IMPARTI		2	5
CH 5B	CH 5C	MOYENNE	10'		3	10
CH8B	CH8C	24,6			4	15
DISTANCES		DIRECTION	INFORMATIONS			DEGRESSIF
TOTAL	PARTIEL					
0,000	0,000	CH 2B 5B 8B 	Sortie Parc Fermée A Droite			4,105
0,046	0,046		1 	 		4,059
0,538	0,492		2 	 		3,567
1,076	0,538		3 	 		3,029
1,407	0,331		4 	 		2,698
2,485	1,078		5 			1,620











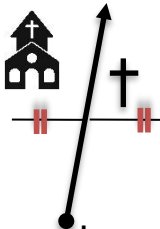

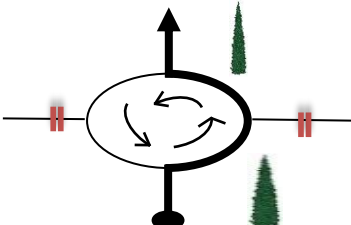

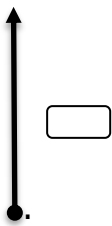

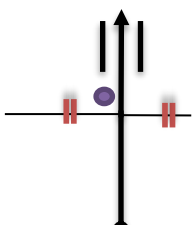
MONTELMAR - MONTELMAR						
CH		DISTANCE	TEMPS		Section	Secteur
CH 2B	CH 2C	4,105	IMPARTI		2	5
CH 5B	CH 5C	MOYENNE	10'		3	10
CH 8B	CH 8C	24,6			4	15
DISTANCES		DIRECTION	INFORMATIONS			DEGRESSIF
TOTAL	PARTIEL					
2,734	0,249		50	7	ZONE ACTIVITES FORTUNEAU	1,371
2,821	0,087		50	8	S.I. RUE DE DION BOUTON	1,284
3,686	0,952		50	9	S.I. VALENCE MONTELMAR-NORD	0,419
3,970	0,284		50	10	AUTAJON SP	0,135
4,105	0,135		30	11	ENTREE ASSISTANCE : A B C D MERCI DE RESPECTER L'ENTREPRISE QUI NOUS ACCUEIL	0,000

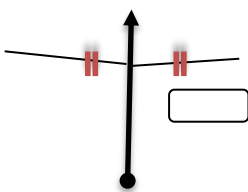
MONTELMAR - SALLES SOUS BOIS



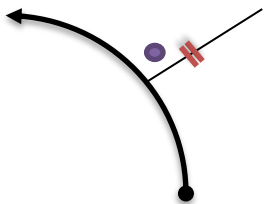







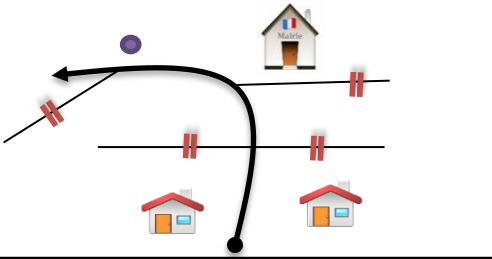

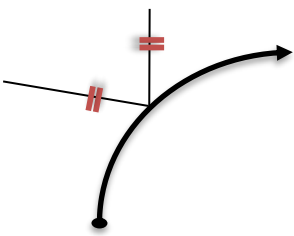
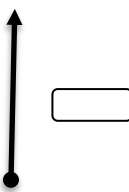

CH		DISTANCE	TEMPS	Section	Secteur
CH 2D	CH 3	30,546	IMPARTI	2	6
CH 5D	CH 6	MOYENNE	40'	3	11
CH 8D	CH 9	42,9		4	16
DISTANCES		DIRECTION	INFORMATIONS		
TOTAL	PARTIEL				
0,000	0,000	<p align="center">CH 2D 5D 8D</p>	<p>SORTIE ASSISTANCE : B C D</p> <p>1</p>		30,546
0,020	0,020		<p>2</p> <p align="center">S.I</p>		30,526
0,108	0,088		<p>3</p> <p align="center"> </p>		30,438
0,873	0,765		<p>4</p> <p align="center"> </p>		29,673
1,563	0,690		<p>5</p> <p align="center"> </p>		28,983
2,146	0,583		<p>6</p> <p align="center"> </p>		28,400

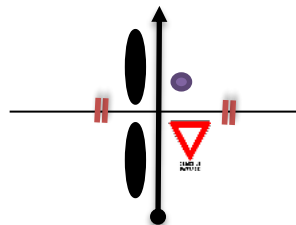
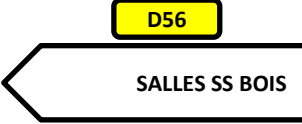
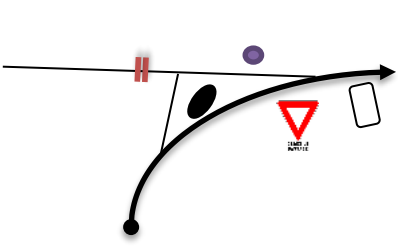

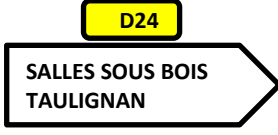

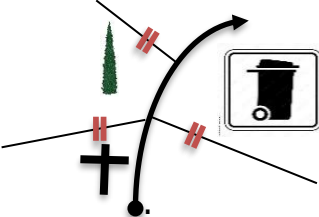
MONTELIMAR - SALLES SOUS BOIS						
CH		DISTANCE	TEMPS		Section	Secteur
CH 2D	CH 3	30,546	IMPARTI		2	6
CH 5D	CH 6	MOYENNE	40'		3	11
CH 8D	CH 9	42,9			4	16
DISTANCES		DIRECTION		INFORMATIONS		
TOTAL	PARTIEL					
X	X				ZONE DE CHANTIER	X
3,339	1,193			7		27,207
3,693	0,354			8		26,853
3,804	0,111	DEBUT ZONE ETALONNAGE VHRS VMRS 		9		26,742
8,264	4,460	FIN DE ZONE ETALONNAGE VHRS VMRS 		10		22,282
8,420	0,156			11		22,126

MONTELMAR - SALLES SOUS BOIS

CH		DISTANCE	TEMPS IMPARTI	Section	Secteur
CH 2D	CH 3			30,546	2
CH 5D		MOYENNE	42,9	3	11
CH 8D				4	16
DISTANCES		DIRECTION	INFORMATIONS		
TOTAL	PARTIEL				
8,901	0,481		 En face S.I 12 		21,645
9,213	0,312		ZONE  S.R.P S.I 13		21,333
9,409	0,196		D56  S.R.P pendant 8,5 KM 14		21,137
18,468	9,059		D56  15		12,078
20,171	1,703		ZONE  D550  16 		10,375
20,534	0,363		ZONE  D56  17 		10,012

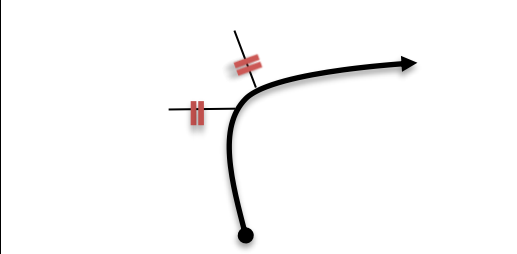
MONTELMAR - SALLES SOUS BOIS

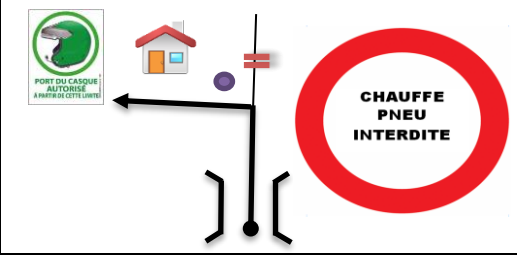
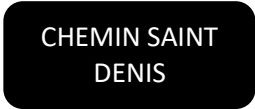
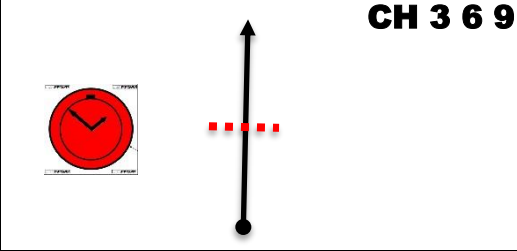
CH		DISTANCE	TEMPS	Section	Secteur
CH 2D	CH 3	30,546	IMPARTI	2	6
CH 5D	CH 6	MOYENNE	40'	3	11
CH 8D	CH 9	42,9		4	16
DISTANCES		DIRECTION	INFORMATIONS		
TOTAL	PARTIEL				
20,616	0,082		 18	 S.R.P 	9,93
20,907	0,291		19	S.R.P	9,639
24,719	3,812		 20	 S.R.P	5,827
26,462	1,743		21		4,084
29,561	3,099		 22	 	0,985
29,732	0,171		 23	 S.I / S.R.P 	0,814

MONTELIMAR - SALLES SOUS BOIS						
CH		DISTANCE	TEMPS		Section	Secteur
CH 2D	CH 3	30,546	IMPARTI		2	6
CH 5D	CH 6	MOYENNE	40'		3	11
CH 8D	CH 9	42,9			4	16
DISTANCES		DIRECTION		INFORMATIONS		
TOTAL	PARTIEL					
30,002	0,270			S.I / S.R.P 	0,544	
30,196	0,194				0,350	
30,546	0,350				0,000	



HOPITAL de MONTÉLIMAR
04-75-53-40-00

ES 2-3-6-9
Salles - Aleyrac
"Notre Dame la Brune"
8,099 Kms







44°29'42.7"N 4°56'23.9"E

- 8,099
- 7,492
- 6,355
- 6,105
- 4,338
- 3,154
- 2,884
- 2,223
- 1,635
- 1,169
- 0,420
- 0,000

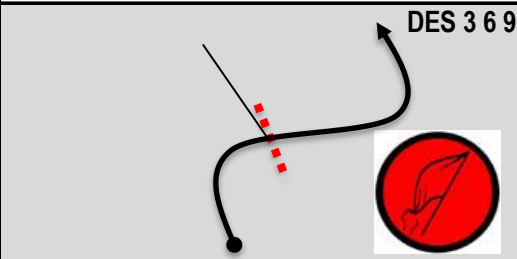
LEGENDE

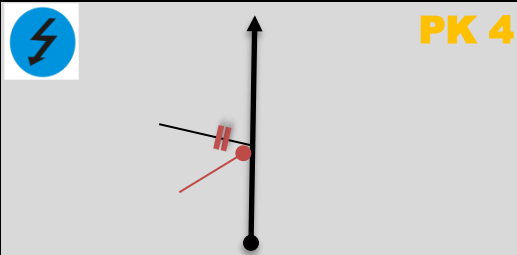
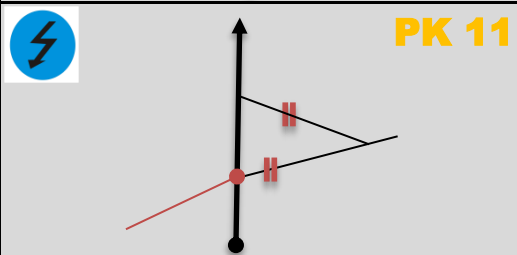
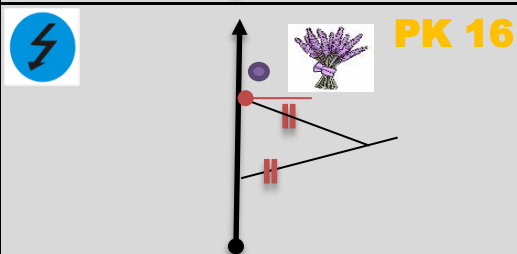
- 1,600 Point kilométrique du poste
- 0,000 Poste commissaire
- 0,000 Poste cibiste
- Radio
- Panneau Contrôle Horaire
- Panneau départ ES
- Position Dépanneuse
- Position Ambulance
- Zone Public
- Panneau arrivée ES
- Panneau Point Stop
- Route d'évacuation
- Sens de l'évacuation
- Parcours épreuve spéciale
- Sens de parcours de l'es

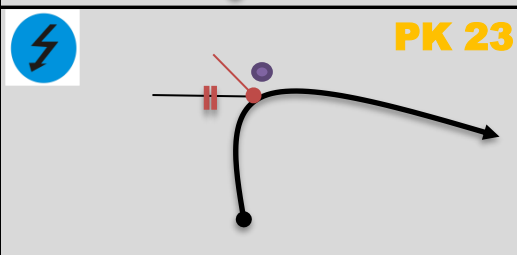
44°27'20.8"N 4°56'18.4"E

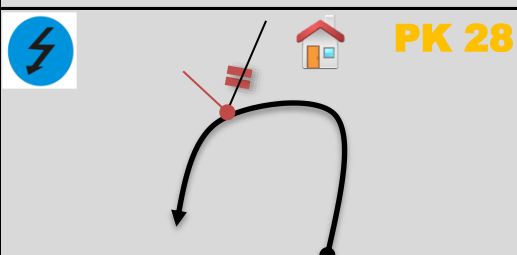
SALLES-SOUS-BOIS - SALLES SOUS BOIS						
CH		DISTANCE	TEMPS		Section	Secteur
DES 3	CH 4	13,559	IMPARTI		2	7
DES 6	CH 5	MOYENNE 41,2	20'		3	12
DES 9	CH 6				4	17
DISTANCES		DIRECTION	INFORMATIONS			DEGRESSIF
TOTAL	PARTIEL					
0,000	0,000			DES 3 6 9	13,559	
0,420	0,420		PK 4	S.R.P Route a gauche (panneau les lapins de bastien)	13,139	
1,169	0,749		PK 11	Double chemin a droite	12,390	
1,635	0,466		PK 16	 S.R.P Route a droite	11,924	
2,335	0,700		PK 23	 Route a gauche	11,224	
2,884	0,549		PK 28	S.R.P Route a droite	10,675	

SALLES-SOUS-BOIS - SALLES SOUS BOIS						
CH		DISTANCE	TEMPS		Section	Secteur
DES 3	CH 4	13,559	IMPARTI		2	7
DES 6	CH 5	MOYENNE 41,2	20'		3	12
DES 9	CH 6				4	17
DISTANCES		DIRECTION	INFORMATIONS			DEGRESSIF
TOTAL	PARTIEL					
3,154	0,270	<p>PK 31</p>	<div style="border: 1px solid black; border-radius: 10px; padding: 5px; text-align: center;"> CHEMIN DU SERRE PUGET </div> <p>Reprise route principale</p>	7	10,405	
4,338	1,184	<p>PK 43</p>	S.R.P Chemin en face	8	9,221	
6,105	1,767	<p>PK 61</p>	S.R.P Chemin a droite	9	7,454	
6,355	0,250	<p>PK 63</p>	S.R.P Chemin de Rialhe	10	7,204	
7,492	1,137	<p>PK 74</p>	S.R.P CHEMIN A DROITE	11	6,067	
8,099	0,607		<p>S.R.P CHEMIN GAUCHE</p>	12	5,460	

SALLES-SOUS-BOIS - SALLES SOUS BOIS						
CH		DISTANCE	TEMPS		Section	Secteur
DES 3	CH 4	13,559	IMPARTI		2	7
DES 6	CH 5	MOYENNE	20'		3	12
DES 9	CH 6	41,2			4	17
DISTANCES		DIRECTION	INFORMATIONS			
TOTAL	PARTIEL		DEGRESSIF			
8,335	0,236			13	5,224	
8,386	0,051			14	5,173	
13,406	5,020			15	0,153	
13,559	0,153			16	0,000	

ES 4 - 7 - 10

LE COLOMBIER

J.P. Mauveaux

13,376Kms

HOPITAL de MONTELMAR
04-75-53-40-00

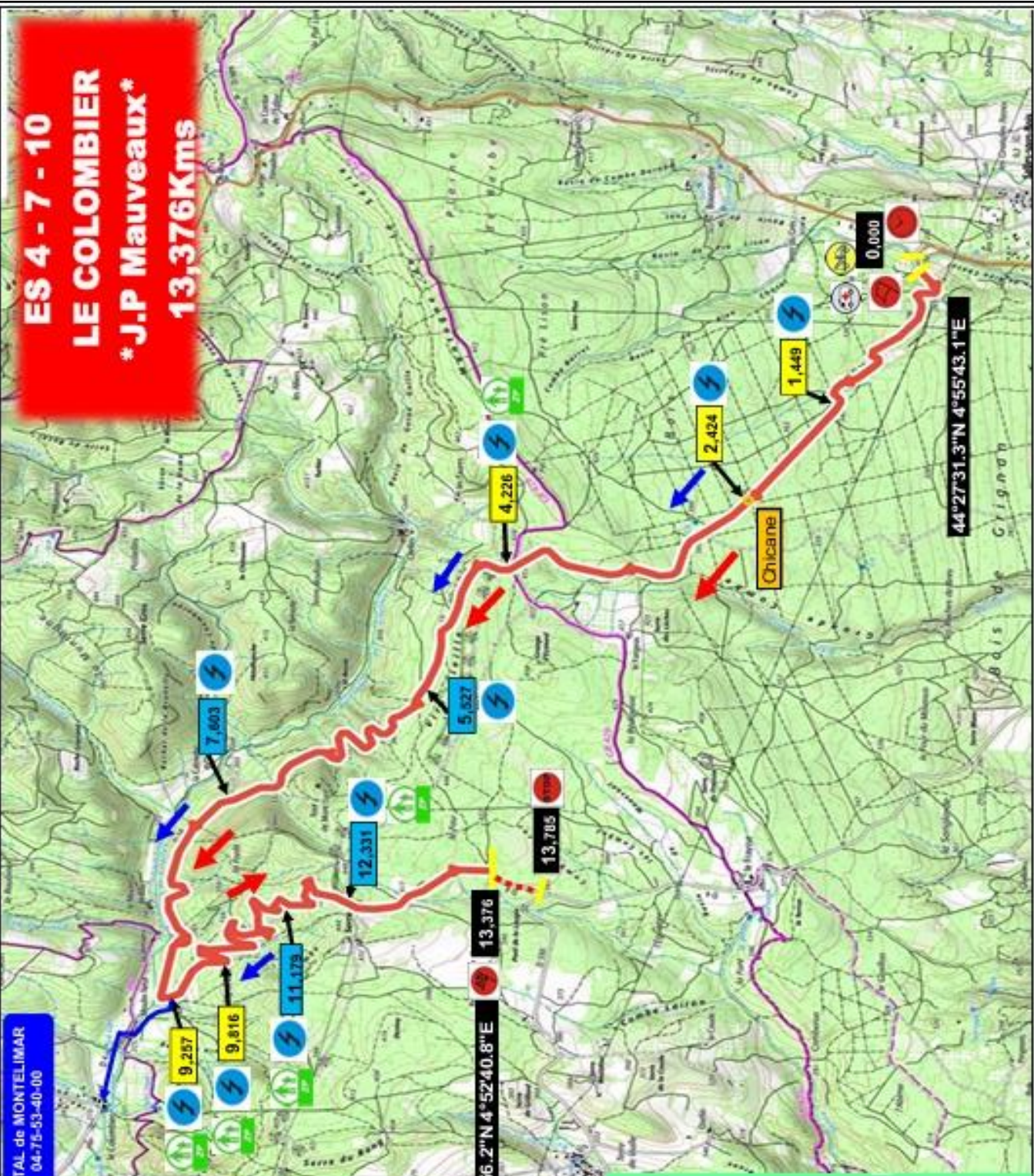

44°28'56.2"N 4°52'40.8"E 13,376

44°27'31.3"N 4°55'43.1"E











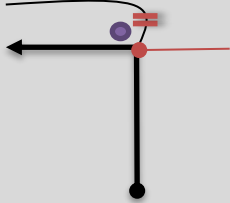

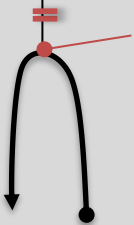
LEGENDE

- 1,600 Point kilométrique du poste
- 0,000 Poste commissaire
- 0,000 Poste cibiste
- Radio
- Panneau Contrôle Horaire
- Panneau départ ES
- Position Dépanneuse
- Position Ambulance
- Zone Public
- Panneau arrivée ES
- Panneau Point Stop
- Route d'évacuation
- Sens de l'évacuation
- Parcours épreuve spéciale
- Sens de parcours de l'es

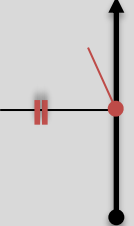

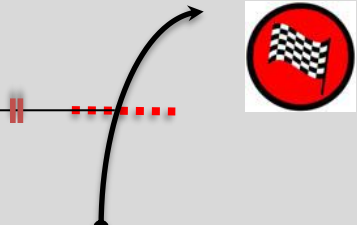

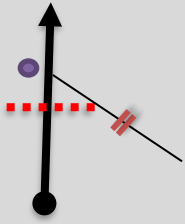



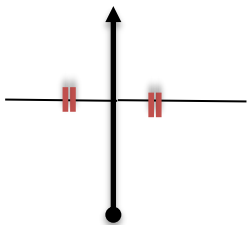
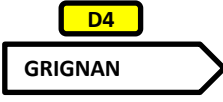
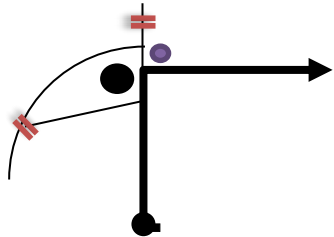

SALLES SOUS BOIS - MONTSEGUR SUR LAUZON

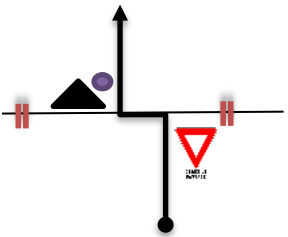
DES		CH	DISTANCE	TEMPS	Section	Secteur
DES 4		CH 5	31,888	IMPARTI	2	8
DES 7		CH 8	MOYENNE 47,8	40'	3	13
DES 10		CH 11			4	18
DISTANCES		DIRECTION		INFORMATIONS		DEGRESSIF
TOTAL	PARTIEL					
0,000	0,000	<p>DES 4 7 10</p>				31,888
1,449	1,449	<p>PK 14</p>		<p>VO Terre a droite</p>		30,439
2,424	0,975	<p>PK 24</p>		<p>ENTREE A DROITE FUTS PLEINS</p> <p>Chicane 50M Après Panneau</p>		29,464
4,226	1,802	<p>EOLIENNES PK 42</p>		<p>Place a droite</p> <p>S.R.P</p> <p>S.I</p>		27,662
5,527	1,301	<p>PK 55</p>		<p>S.R.P</p> <p>S.I</p>		26,361
7,603	2,076	<p>PK 76</p>		<p>S.R.P</p> <p>S.I</p>		24,285

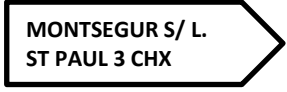
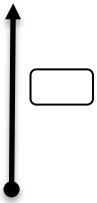
SALLES SOUS BOIS - MONTSEGUR SUR LAUZON

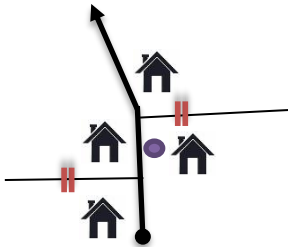
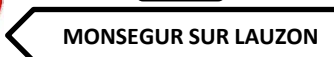
DES		CH	DISTANCE	TEMPS	Section	Secteur
DES 4		CH 5	31,888	IMPARTI	2	8
DES 7		CH 8	MOYENNE 47,8	40'	3	13
DES 10		CH 11			4	18
DISTANCES		DIRECTION		INFORMATIONS		DEGRESSIF
TOTAL	PARTIEL					
9,257	1,654		 <p>PK 92</p>	<p>D4</p> 		22,631
9,816	0,559		 <p>PK 98</p>	<p>D4</p> <p>S.R.P</p> <p>S.I</p>		22,072
11,179	1,363		 <p>PK 111</p>	<p>D4</p> <p>S.R.P</p> <p>S.I</p>		20,709
12,331	1,152		 <p>PK 1123</p>	<p>D4</p> 		19,557
13,376	1,045					18,512
13,785	0,409			<p>D4</p> 		18,103

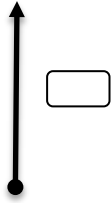
SALLES SOUS BOIS - MONTSEGUR SUR LAUZON

DES	CH	DISTANCE	TEMPS	Section	Secteur
DES 4	CH 5	31,888	IMPARTI	2	8
DES 7	CH 8	MOYENNE	40'	3	13
DES 10	CH 11	47,8		4	18
DISTANCES		DIRECTION	INFORMATIONS	DEGRESSIF	
TOTAL	PARTIEL				
20,040	6,255		<div style="border: 1px solid black; padding: 2px; display: inline-block; background-color: yellow;">D4</div> 	13	11,848
20,975	0,935		 ! PEU VISIBLE !	14	10,913
22,584	1,609		<div style="border: 1px solid black; padding: 2px; display: inline-block; background-color: yellow;">D71</div>  	15	9,304
25,042	2,458		<div style="border: 1px solid red; border-radius: 50%; padding: 5px; display: inline-block; color: white; font-weight: bold;">50</div> <div style="border: 1px solid black; padding: 2px; display: inline-block; background-color: yellow;">D71</div> 	16	6,846
25,684	0,642		<div style="border: 1px solid red; border-radius: 50%; padding: 5px; display: inline-block; color: white; font-weight: bold;">50</div> <div style="border: 1px solid black; padding: 2px; display: inline-block; background-color: yellow;">D71</div>  	17	6,204
29,935	4,251		<div style="border: 1px solid red; border-radius: 50%; padding: 5px; display: inline-block; color: white; font-weight: bold;">50</div> <div style="border: 1px solid black; padding: 2px; display: inline-block; background-color: yellow;">D71</div> 	18	1,953

SALLES SOUS BOIS - MONTSEGUR SUR LAUZON

DES		CH	DISTANCE	TEMPS	Section	Secteur
DES 4		CH 5	31,888	IMPARTI	2	8
DES 7		CH 8	MOYENNE 47,8	40'	3	13
DES 10		CH 11			4	18
DISTANCES		DIRECTION		INFORMATIONS		DEGRESSIF
TOTAL	PARTIEL					
30,422	0,487					1,466
30,778	0,356					1,110
31,648	0,870					0,240
31,888	0,240					0,000

ES 5 - 8 - 11

Montsegur

* Bassin des Druides*



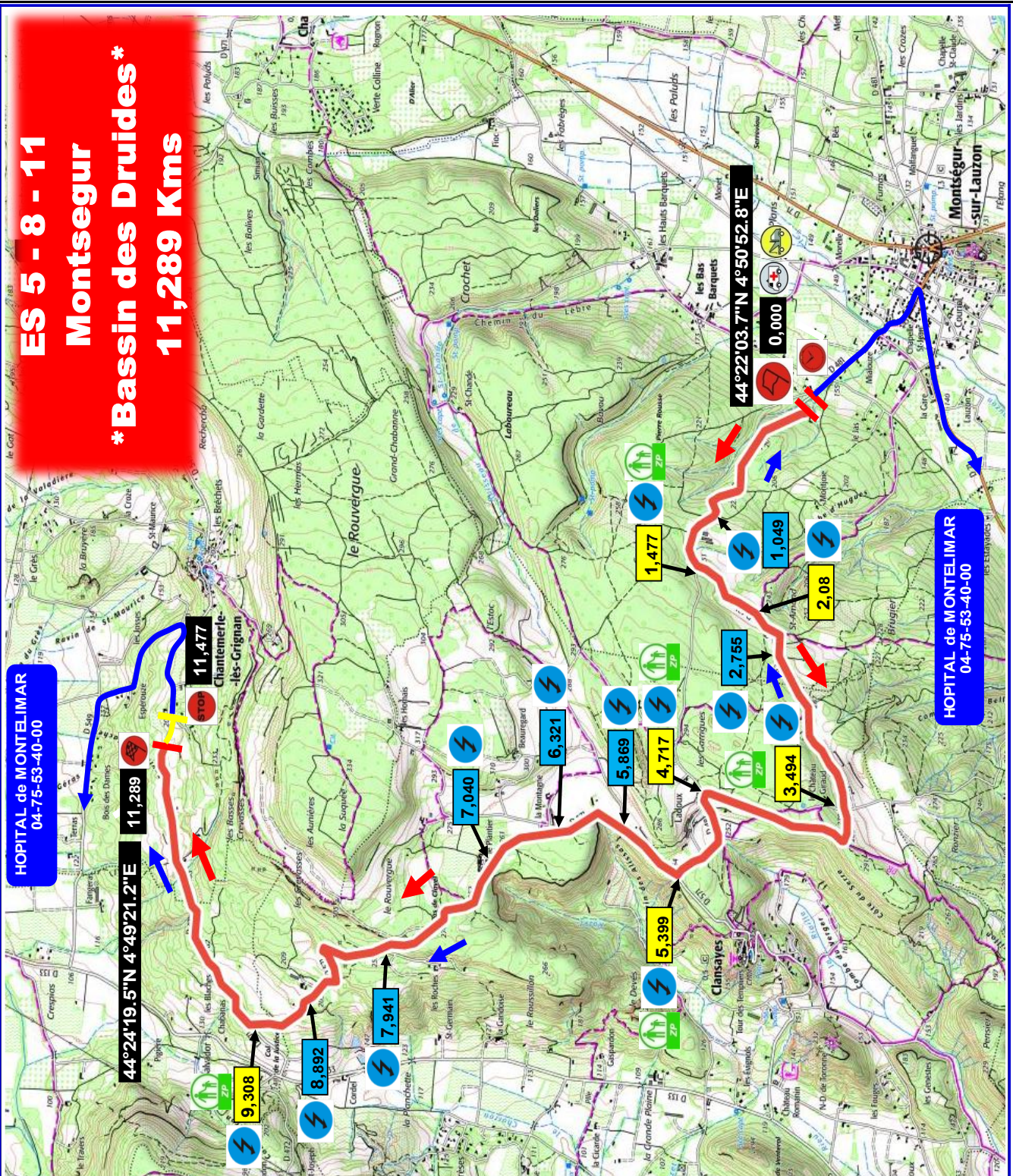





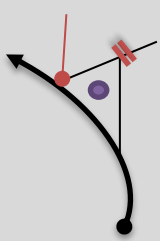

11,289 Kms

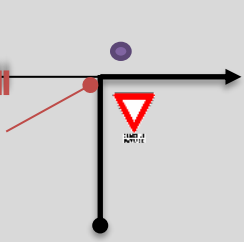

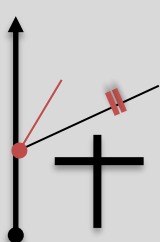

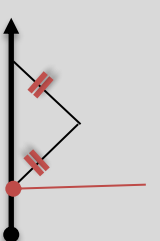

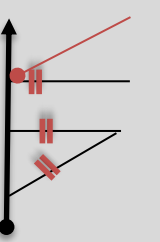

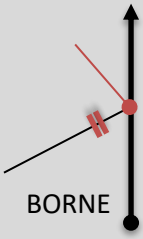

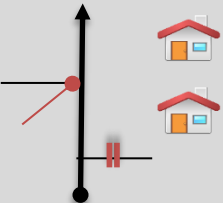

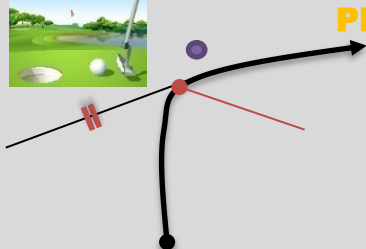

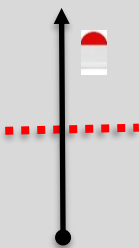

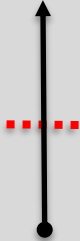

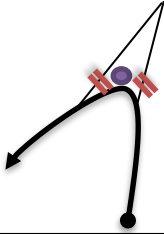

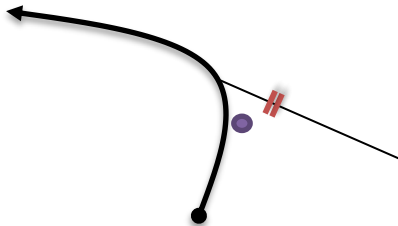
LEGENDE

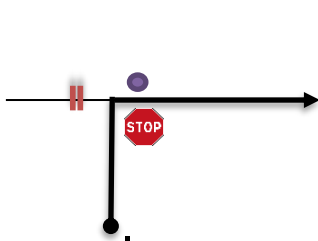
- 1,600 Point kilométrique du poste
- 0,000 Poste commissaire
- 0,000 Poste cibiste
- Radio
- Panneau Contrôle Horaire
- Panneau départ ES
- Position Dépanneuse
- Position Ambulance
- Zone Public
- Panneau arrivée ES
- Panneau Point Stop
- Route d'évacuation
- Sens de l'évacuation
- Parcours éprouve spéciale
- Sens de parcours de l'es

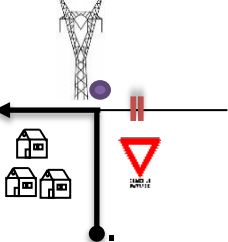
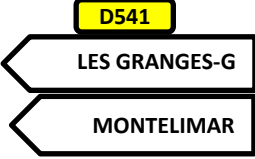
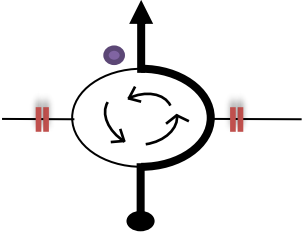
MONTSEGUR SUR LAUZON - MONTELMAR						
CH		DISTANCE	TEMPS		Section	Secteur
DES 5	CH 5A	38,411	IMPARTI		2	9
DES 8	CH 8A	MOYENNE	45'		3	14
DES 11	CH 11A	48			4	19
DISTANCES		DIRECTION		INFORMATIONS		DEGRESSIF
TOTAL	PARTIEL					
0,000	0,000	DES 5 8 11		D481		38,410
1,049	1,049	PK 10		D481 S.R.P S.I		37,361
1,477	0,428	PK 14		CLANSAYES		36,933
2,100	0,623	PK 24		S.R.P S.I Chemin a gauche		36,310
2,755	1,278	PK 27		D481 S.R.P S.I		35,655
3,494	0,739	PK 34		CLANSAYES		34,916

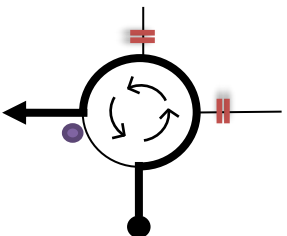
MONTSEGUR SUR LAUZON - MONTELMAR						
CH		DISTANCE	TEMPS		Section	Secteur
DES 5	CH 5A	38,411	IMPARTI		2	9
DES 8	CH 8A	MOYENNE	45'		3	14
DES 11	CH 11A	48			4	19
DISTANCES		DIRECTION	INFORMATIONS			DEGRESSIF
TOTAL	PARTIEL					
4,717	1,223	  PK 47	D481 CLANSAYES	7		33,693
5,399	0,682	  PK 53	D571 VALAURIE	8		33,011
5,869	0,470	  PK 58	D571 S.R.P S.I	9		32,541
6,321	0,452	  PK 63	D571 S.R.P S.I	10		32,089
7,040	0,719	  PK 70	D571 S.R.P S.I	11		31,370
7,941	0,901	  PK 79 BORNE	D571 S.R.P S.I	12		30,469

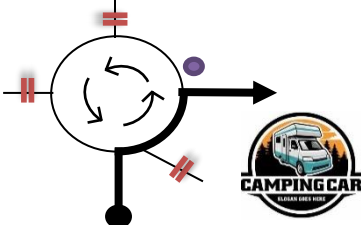
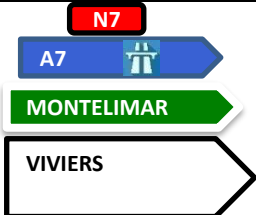
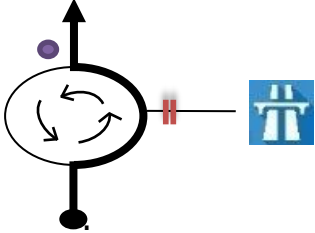
MONTSEGUR SUR LAUZON - MONTELMAR						
CH		DISTANCE	TEMPS		Section	Secteur
DES 5	CH 5A	38,411	IMPARTI		2	9
DES 8	CH 8A	MOYENNE 48	45'		3	14
DES 11	CH 11A				4	19
DISTANCES		DIRECTION	INFORMATIONS			DEGRESSIF
TOTAL	PARTIEL					
8,892	0,951	  PK 88	D571 S.R.P S.I	13	29,518	
9,308	0,416	   PK 93	D471 CHANTEMERLE LES GRIGNAN	14	29,102	
11,289	1,981	  AES		15	27,121	
11,477	0,188	  		16	26,933	
12,080	0,603	 	ZONE 30 MAS DES LAURELS CURLY DE PROVENCE	17	26,330	
12,958	0,878		ZONE 30 D549 MONTELMAR	18	25,452	

MONTSEGUR SUR LAUZON - MONTELIMAR						
CH		DISTANCE	TEMPS		Section	Secteur
DES 5	CH 5A	38,411	IMPARTI		2	9
DES 8	CH 8A	MOYENNE 48	45'		3	14
DES 11	CH 11A				4	19
DISTANCES		DIRECTION	INFORMATIONS			DEGRESSIF
TOTAL	PARTIEL					
14,700	1,742		19		23,710	
15,684	0,984		20		22,726	
16,753	1,069		21		21,657	
23,428	6,675		22		14,982	
23,863	0,435		23		14,547	
26,262	2,399		24		12,148	

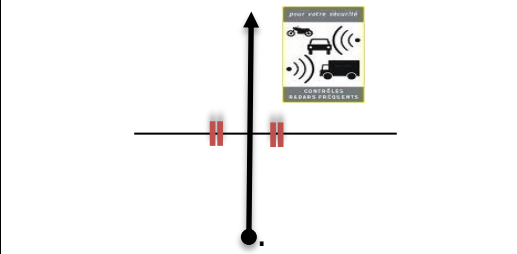
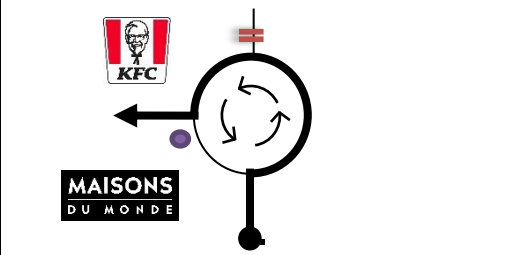
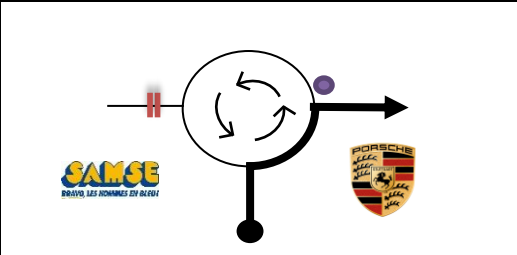
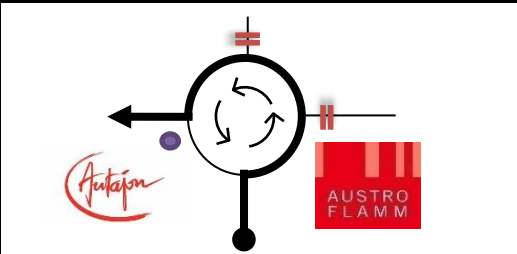
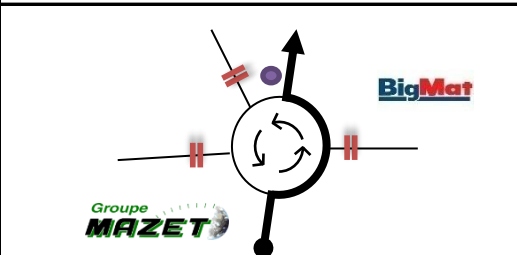
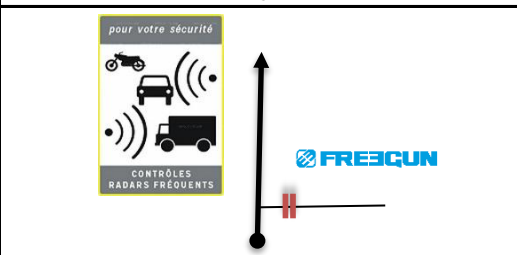
MONTSEGUR SUR LAUZON - MONTELMAR						
CH		DISTANCE	TEMPS		Section	Secteur
DES 5	CH 5A	38,411	IMPARTI		2	9
DES 8	CH 8A	MOYENNE	45'		3	14
DES 11	CH 11A	48			4	19
DISTANCES		DIRECTION	INFORMATIONS			DEGRESSIF
TOTAL	PARTIEL					
27,700	1,438		N7 S.R.P S.I			10,710
32,084	4,384		70 ZONES ACTIVITES			6,326
33,103	1,019		70 D73 MONTELMAR			5,307
33,686	0,583		70 N7 VALENCE PRIVAS AUBENAS / LE PUY			4,724
34,496	0,810		50 N7 VALENCE PRIVAS AUBENAS / LE PUY ROCHEMAURE / LE TEIL			3,914
34,992	0,496		N7 !! RADAR DOUBLE SENS !! 80 km/h			3,418

MONTSEGUR SUR LAUZON - MONTELMAR						
CH		DISTANCE	TEMPS		Section	Secteur
DES 5	CH 5A	38,411	IMPARTI		2	9
DES 8	CH 8A	MOYENNE 48	45'		3	14
DES 11	CH 11A				4	19
DISTANCES		DIRECTION	INFORMATIONS			DEGRESSIF
TOTAL	PARTIEL					
35,970	0,978				31	2,440
37,000	1,030			 	32	1,410
37,238	0,238			 	33	1,172
37,783	0,545			S.R.P S.I	34	0,627
38,314	0,531			 	35	0,096
38,410	0,096			A DROITE ENTREE PARC FERMEE PARKING PALAIS DES CONGRES	36	0,000

COUPE DE FRANCE DES RALLYES PEA COEF. 3

FFSA

39EME RALLYE DU NOUGAT

DE MONTELMAR DROME PROVENCAL

17EME VHC 14EME VHRS 4EME VMRS

ROAD-BOOK



DÉLÉSTAGE





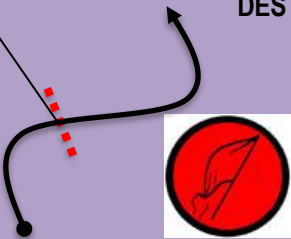

29 ET 30 MAI 2026

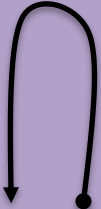
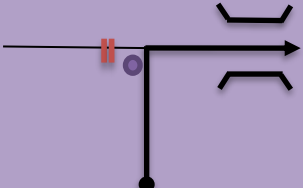
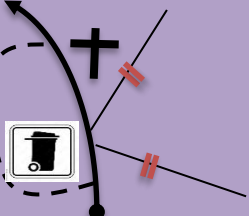
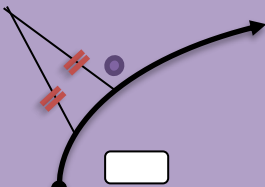
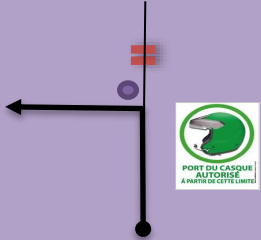





DELESTAGE ALEYRAC - LA CITELLE

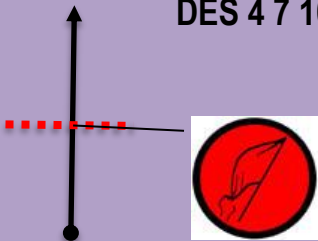

DES		CH	DISTANCE	TEMPS	Section	Secteur
ES 3 6 9			1,850	IMPARTI		
			MOYENNE XX	XX'		
DISTANCES		DIRECTION		INFORMATIONS		DEGRESSIF
TOTAL	PARTIEL					
0,000	0,000					1,85
0,000	0,000			FAIRE DEMI-TOUR		1,850
0,300	0,300			CHEMIN SAINT DENIS		1,550
0,750	0,450			S.R.P S.I		1,100
0,850	0,100			D24 ESPELUCHE MONTELIMAR SALES SOUS BOIS		1,000
1,750	0,900			D24 ROCHEFORT EN V ESPELUCHE MONTELIMAR		0,100

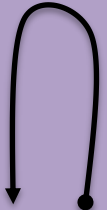
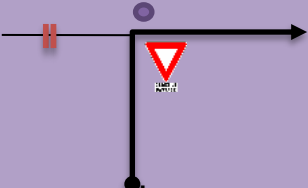
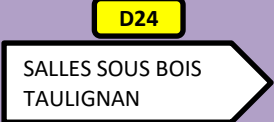
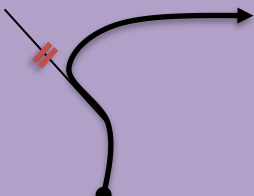
DELESTAGE ALEYRAC - LA CITELLE						
DES	CH	DISTANCE	TEMPS		Section Secteur	
ES 3 6 9		1,850	IMPARTI		 PORT DU CASQUE INTERDIT A PARTIR DE CETTE LIMITE	
		MOYENNE XX	XX'			
DISTANCES		DIRECTION			INFORMATIONS	DEGRESSIF
TOTAL	PARTIEL					
1,850	0,100	  				0,000

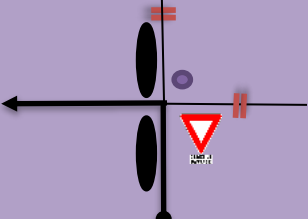
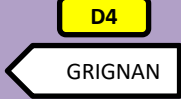

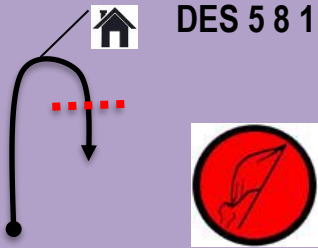

DELESTAGE LA CITELLE - BASSIN DES DRUIDES

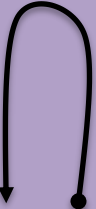
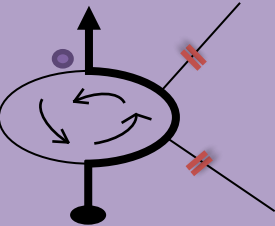
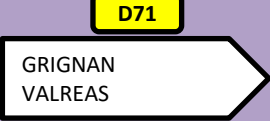
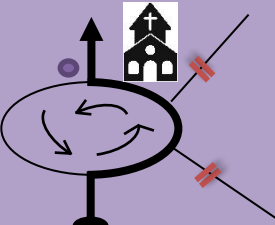
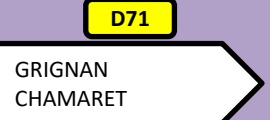
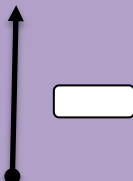
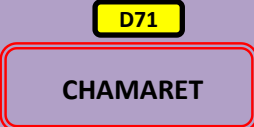
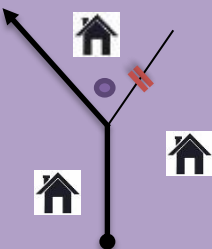
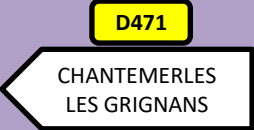
DES		CH	DISTANCE	TEMPS	Section	Secteur
ES 4 7 10			4,000	IMPARTI		
			MOYENNE XX	XX'		
DISTANCES		DIRECTION			INFORMATIONS	
TOTAL	PARTIEL				DEGRESSIF	
0,000	0,000					
0,000	0,000				<p>FAIRE DEMI-TOUR</p>	
0,000	0,000					
0,900	0,900					
4,000	3,100				 <p>REPRENDRE ROADBOOK PAGE 20 CASE 13</p>	

DELESTAGE BASSIN DES DRUIDES - PARC FERMEE

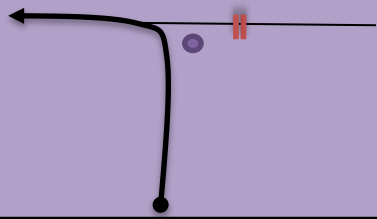
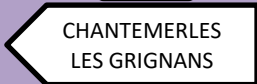
CH		CH		DISTANCE	TEMPS	Section	Secteur
ES 5 8 11		11,500		MOYENNE	IMPARTI		
		XX		XX'			
DISTANCES		DIRECTION		INFORMATIONS			DEGRESSIF
TOTAL	PARTIEL						
0,000	0,000						11,500
0,000	0,000			<p>FAIRE DEMI-TOUR</p>			11,500
0,800	0,800						10,700
1,200	0,400						10,300
5,300	4,100						6,200
5,500	0,200						6,000

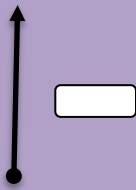
DELESTAGE BASSIN DES DRUIDES - PARC FERMEE

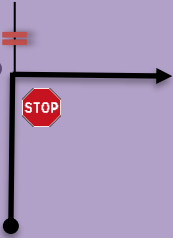
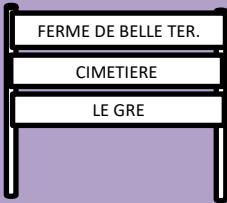
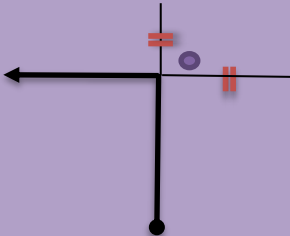
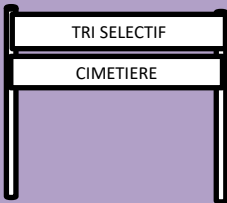
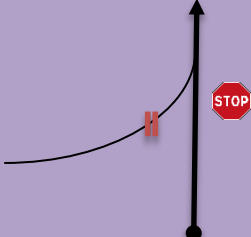
CH		DISTANCE	TEMPS	Section	Secteur
ES 5 8 11		11,500	IMPARTI		
		MOYENNE	XX'		
DISTANCES		DIRECTION		INFORMATIONS	DEGRESSIF
TOTAL	PARTIEL				
7,600	2,100			D471 	3,900
9,200	1,600			S.R.P S.I	2,300
9,700	0,500				1,800
9,800	0,100				1,700
10,150	0,350				1,350
11,500	1,350			REPRENDRE ROADBOOK PAGE 25 CASE 18	0,000