

COUPE DE FRANCE DES RALLYES PEA COEF. 3

FFSA

39EME RALLYE DU NOUGAT

DE MONTELMAR DROME PROVENCAL

17EME VHC 14EME VHRS 4EME VMRS

**ROAD-BOOK
MODERNE ET VHC**



29 ET 30 MAI 2026





ANNEXE N° 1 ITINÉRAIRE
Rallye National du Nougat de Montélimar Drôme Provençale 2026
VHC & MODERNE



Kms	Liaison	11 - ES	ITINÉRAIRE		H.Théorique	H.Théorique
386,576	267,835	118,741			Première	Dernière

VENDREDI 29 mai 2026 1ère Etape MONTELMAR / MONTELMAR VHC - Moderne						
	Postes	Routes	Imparti		Moyenne	
4,105	Secteur 1		00 H 10	MONTELMAR - MONTELMAR	24,6 Kh	
0,0	CH 0			Sortie Parc Palais des Congrès 1er VHC	19 H 15	21 H 35
4,105	CH 0a	VO	00 H 10	Entrée Parc Assistance Autajon S-P	19 H 25	21 H 45
			00 H 20	PARC ASSISTANCE MONTELMAR		
15,300	Secteur 2		00 H 25	MONTELMAR - ROCHEFORT EN VALDAINE	36,7 Kh	
0,0	CH 0b	VO		Sortie Parc Assistance Autajon Santé	19 H 45	22 H 05
15,300	CH 1	D 127	00 H 25	Rochefort en Valdaïne	20 H 10	22 H 30
14,200	Secteur 3		00 H 20	ROCHEFORT EN VALDAINE - SALLES sous BOIS	42,6 Kh	
0,0	DES 1	D 127	00 H 03	DES Epreuve Rochefort en Valdaïne - "JP Tacussel"	20 H 13	22 H 33
12,350	AES 1	D 24		AES Epreuve Rochefort en Valdaïne - "JP Tacussel"		
14,200	CH 2	VO	00 H 20	Salles sous Bois	20 H 33	22 H 53
32,400	Secteur 4		00 H 50	SALLES SOUS BOIS - MONTELMAR	38,8 Kh	
0,0	DES 2	VO	00 H 03	DES Epreuve Salles sous Bois Aleyrac "Notre dame la Brune"	20 H 36	22 H 56
8,099	AES 2	D 809		AES Epreuve Salles sous Bois Aleyrac "Notre dame la Brune"		
32,400	CH 2a		00 H 50	Entrée parc Montélimar Palais des Congrès fin 1ère étape	21 H 26	23 H 46
SAMEDI 30 mai 2026 2ème ETAPE MONTELMAR / MONTELMAR VHRS - VMRS - VHC - Moderne						
4,105	Secteur 5		00 H 10	MONTELMAR - MONTELMAR	24,6 Kh	
0,0	CH 2b			Sortie Parc Palais des Congrès 1er VHRS	07 H 30	10 H 45
4,105	CH 2c	VO	00 H 10	Entrée Parc Entrée Parc Assistance Autajon S-P	07 H 40	10 H 55
			00 H 45	PARC ASSISTANCE MONTELMAR		
30,546	Secteur 6		00 H 40	MONTELMAR - SALLES sous BOIS	45,8 Kh	
0,0	CH 2d	VO		Sortie Parc Assistance Autajon Santé	08 H 25	11 H 40
30,546	CH 3	VO	00 H 40	Salles sous bois	09 H 05	12 H 20
13,759	Secteur 7		00 H 20	SALLES sous BOIS - SALLES sous BOIS	41,2 Kh	
0,0	DES 3	D VO	00 H 03	DES Epreuve Salles sous Bois Aleyrac "Notre dame la Brune"	09 H 08	12 H 23
8,099	AES 3	D 809		AES Epreuve Salles sous Bois Aleyrac "Notre dame la Brune"		
13,759	CH 4	D V24	00 H 20	Salles sous Bois	09 H 28	12 H 43
31,888	Secteur 8		00 H 40	SALLES sous BOIS - MONTSEGUR sur LAUZON	47,8 Kh	
0,0	DES 4	D 24	00 H 03	Départ Epreuve Le Colombier "Citelles"	09 H 31	12 H 46
13,376	AES 4	D 4		Arrivée Epreuve Le Colombier "Citelles"		
31,888	CH 5	D 481	00 H 40	Montsegur sur Lauzon	10 H 11	13 H 26
38,411	Secteur 9		00 H 45	MONTSEGUR sur LAUZON - MONTELMAR	51,2 Kh	
0,000	DES 5	D 481	00 H 03	DES Epreuve Montségur/Lauzon " Bassin des Druides"	10 H 14	13 H 29
11,289	AES 5	D 471		AES Epreuve Montségur/Lauzon " Bassin des Druides"		
38,411	CH 5a		00 H 45	Entrée Parc Regroupement Palais des Congrès Montélimar	10 H 59	14 H 14
			01 H 00	PARC REGROUPEMENT MONTELMAR		
SAMEDI 30 mai 2026 2ème ETAPE MONTELMAR / MONTELMAR VHRS - VMRS - VHC - Moderne						
4,105	Secteur 10		00 H 10	MONTELMAR - MONTELMAR	24,6 Kh	
0,0	CH 5b			Sortie Parc Regroupement Palais des Congrès 1er VHRS	11 H 59	15 H 14
4,105	CH 5c	VO	00 H 10	Entrée Parc Entrée Parc Assistance Autajon S-P	12 H 09	15 H 24
			00 H 40	PARC ASSISTANCE MONTELMAR		
30,546	Secteur 11		00 H 40	MONTELMAR - SALLES sous BOIS	45,8 Kh	
0,0	CH 5d	VO		Sortie Parc Assistance Autajon Santé	12 H 49	16 H 04
30,546	CH 6	VO	00 H 40	Salles sous bois	13 H 29	16 H 44
14,200	Secteur 12		00 H 20	SALLES sous BOIS - SALLES sous BOIS	41,2 Kh	
0,0	DES 6	VO	00 H 03	DES Epreuve Salles sous Bois Aleyrac "Notre dame la Brune"	13 H 32	16 H 47
8,099	AES 6	D 809		AES Epreuve Salles sous Bois Aleyrac "Notre dame la Brune"		
14,200	CH 7	D 24	00 H 20	Salles sous Bois	13 H 52	17 H 07
27,850	Secteur 13		00 H 40	SALLES sous BOIS - MONTSEGUR sur LAUZON	47,8 Kh	
0,0	DES 7	D 24	00 H 03	Départ Epreuve Le Colombier "Citelles"	13 H 55	17 H 10
13,376	AES 7	D 4		Arrivée Epreuve Le Colombier "Citelles"		
31,888	CH 8	D 481	00 H 40	Montsegur sur Lauzon	14 H 35	17 H 50
38,411	Secteur 14		00 H 45	MONTSEGUR sur LAUZON - MONTELMAR	51,2 Kh	
0,000	DES 8	D 481	00 H 03	DES Epreuve Montségur/Lauzon " Bassin des Druides"	14 H 38	17 H 53
11,289	AES 8	D 471		AES Epreuve Montségur/Lauzon " Bassin des Druides"		
38,411	CH 8a		00 H 45	Entrée Parc Regroupement Palais des Congrès Montélimar	15 H 23	18 H 38
			00 H 50	PARC REGROUPEMENT MONTELMAR		
SAMEDI 30 mai 2026 2ème ETAPE MONTELMAR / MONTELMAR VHRS - VMRS - VHC - Moderne						
4,105	Secteur 15		00 H 10	MONTELMAR - MONTELMAR	24,6 Kh	
0,0	CH 8b			Sortie Parc Regroupement Palais des Congrès 1er VHRS	16 H 13	19 H 28
4,105	CH 8c	VO	00 H 10	Entrée Parc Entrée Parc Assistance Autajon S-P	16 H 23	19 H 38
			00 H 40	PARC ASSISTANCE MONTELMAR		
30,546	Secteur 16		00 H 40	MONTELMAR - SALLES sous BOIS	45,8 Kh	
0,0	CH 8 d	VO		Sortie Parc Assistance Autajon Santé	17 H 03	20 H 18
30,546	CH 9	VO	00 H 40	Salles sous bois	17 H 43	20 H 58
14,200	Secteur 17		00 H 20	SALLES sous BOIS - SALLES sous BOIS	41,2 Kh	
0,0	DES 9	VO	00 H 03	DES Epreuve Salles sous Bois Aleyrac "Notre dame la Brune"	17 H 46	21 H 01
8,099	AES 9	D 809		AES Epreuve Salles sous Bois Aleyrac "Notre dame la Brune"		
14,200	CH 10	D 24	00 H 20	Salles sous Bois	18 H 06	21 H 21
31,888	Secteur 18		00 H 40	SALLES sous BOIS - MONTSEGUR sur LAUZON	47,8 Kh	
0,0	DES 10	D 24	00 H 03	Départ Epreuve Le Colombier "Citelles"	18 H 09	21 H 24
13,376	AES 10	D 4		Arrivée Epreuve Le Colombier "Citelles"		
31,888	CH 11	D 481	00 H 40	Montsegur sur Lauzon	18 H 49	22 H 04
38,411	Secteur 19		00 H 45	MONTSEGUR sur LAUZON - MONTELMAR	51,2 Kh	
0,000	DES 11	D 481	00 H 03	DES Epreuve Montségur/Lauzon " Bassin des Druides"	18 H 52	22 H 07
11,289	AES 11	D 471		AES Epreuve Montségur/Lauzon " Bassin des Druides"		
38,411	CH 11a		00 H 45	Entrée Parc Final Palais des Congrès Montélimar 1er VHRS	19 H 37	22 H 52

1ère ETAPE 1ère SECTION

2ème ETAPE 2ème SECTION

2ème ETAPE 3ème SECTION

2ème ETAPE 4ème SECTION

39ÈME RALLYE NATIONAL DU NOUGAT DE MONTELMAR DRÔME PROVENÇALE

17ÈME VHC

Vendredi 29 mai 2026

SÉCURITÉ RALLYE
FFSAI

AMIS SPECTATEURS,
LES SEULS ENDROITS
AUTORISÉS
SONT
MATÉRIALISÉS
PAR DU VERT*
SUIVEZ LES FLÈCHES!

LA SÉCURITÉ EN RALLYE, C'EST L'AFFAIRE DE TOUS!

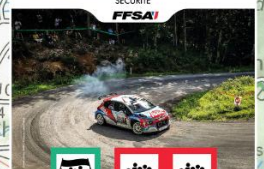

ZONE INTERDITE
AMENDE

LES CONVENTIONS SERONT PASSÉES D'UN AMENDE DE 105 €.

- Liaisons
- Spéciales
- Départ de spéciale
- Arrivée de spéciale
- Zone public

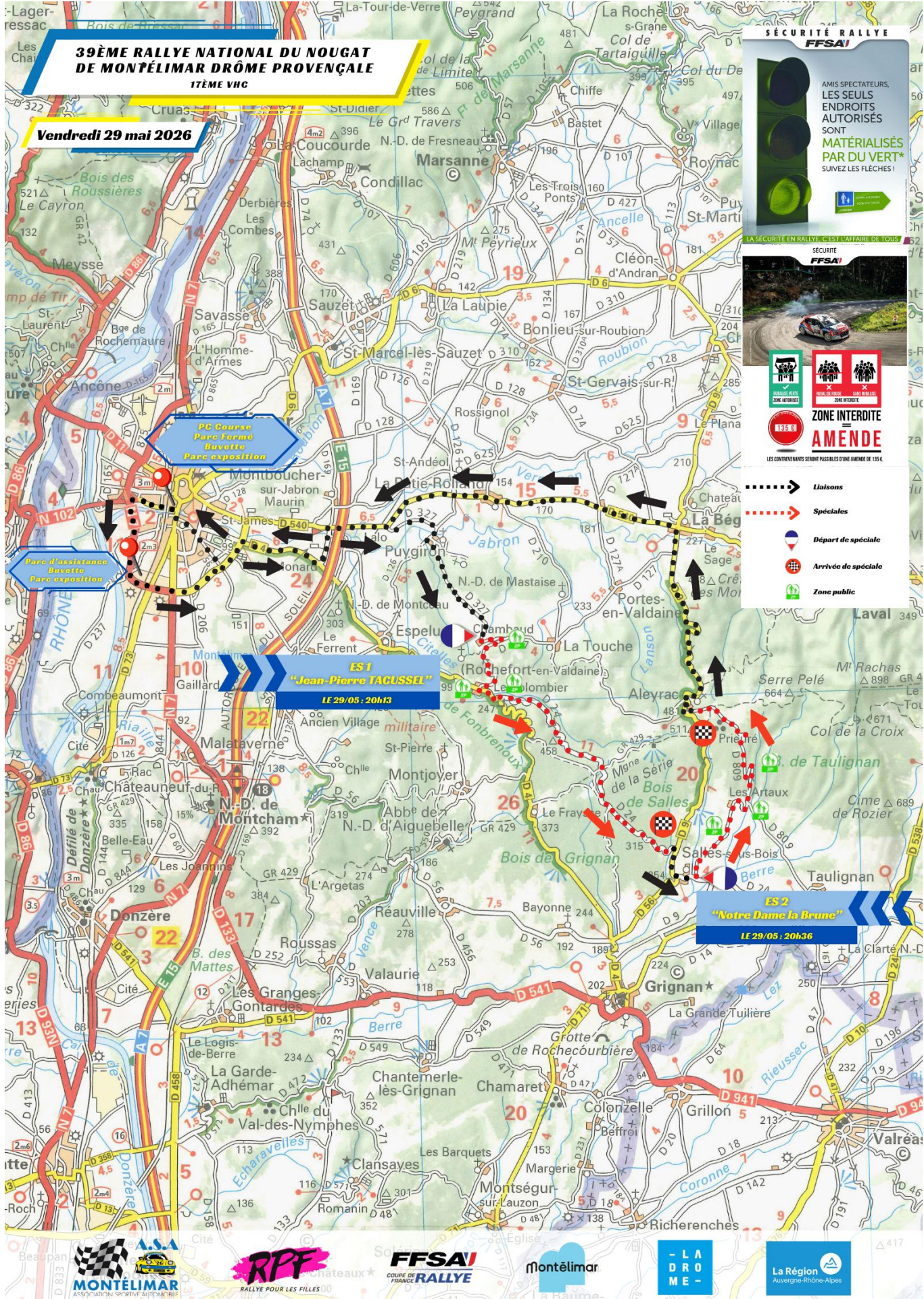

PG Course
Parc Fermé
Buvette
Parc exposition

Parc d'assistance
Buvette
Parc exposition

ES 1
"Jean-Pierre TAGUSSEL"
LE 29/05 - 20h13

ES 2
"Notre Dame la Brune"
LE 29/05 - 20h36



39ÈME RALLYE NATIONAL DU NOUGAT DE MONTÉLIMAR DRÔME PROVENÇALE

17ÈME VHC - 14ÈME VHRS - 4ÈME VMRS

Samedi 30 mai 2026

SÉCURITÉ RALLYE
FFSAI



LA SÉCURITÉ EN RALLYE, C'EST L'AFFAIRE DE TOUS

SÉCURITÉ
FFSAI



ZONE INTERDITE
AMENDE

LES CONTREVENANTS SERONT PASSÉS EN D'AMENDE DE 105 €.

- > Liaisons
- > Spéciales
- 🇫🇷 Départ de spéciale
- 🏁 Arrivée de spéciale
- 🌳 Zone public

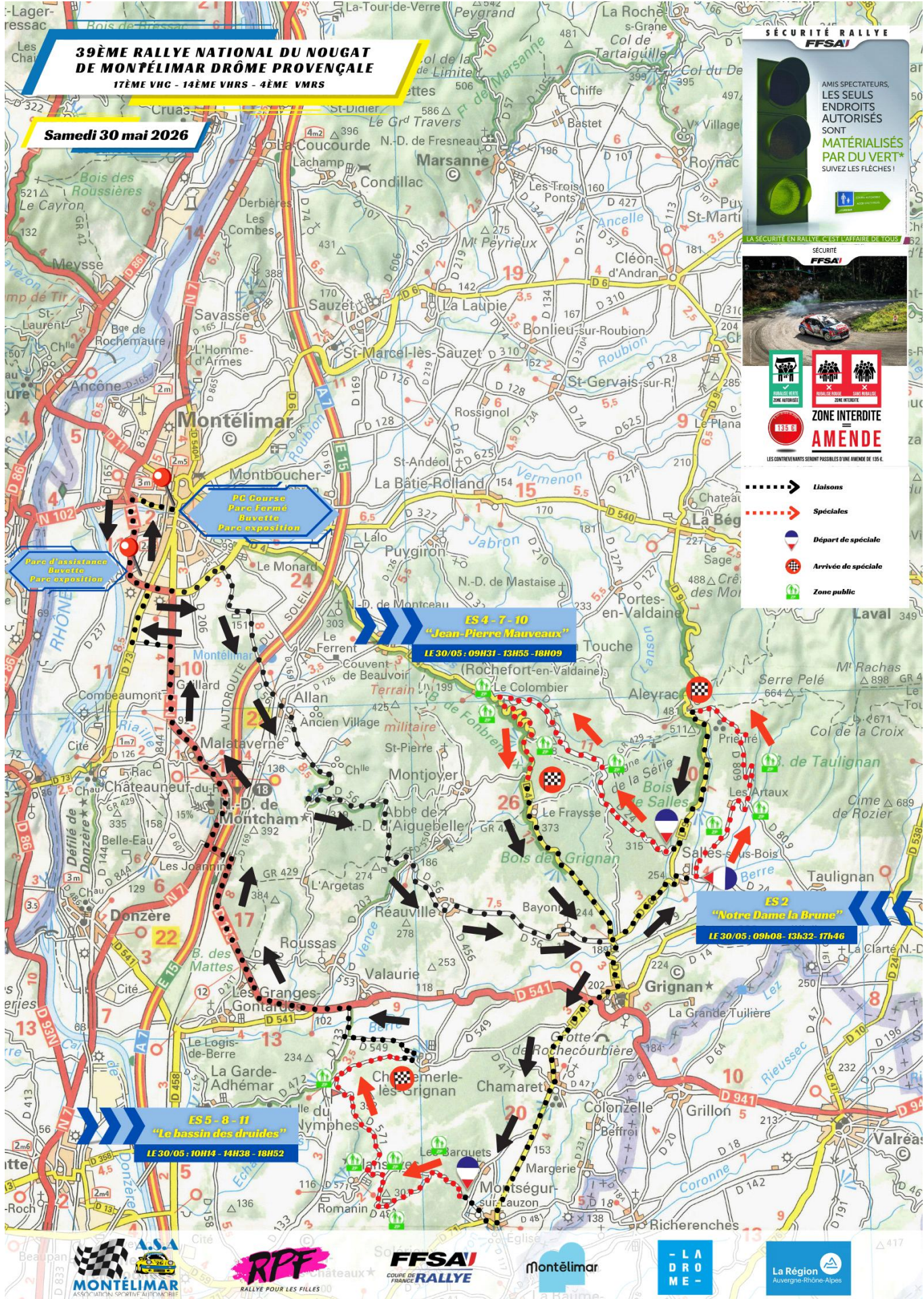

ES 5 - 8 - 11
"Le bassin des druides"
LE 30/05 : 10H14 - 14H38 - 18H52

ES 4 - 7 - 10
"Jean-Pierre Mauveaux"
LE 30/05 : 09H31 - 13H55 - 18H09

ES 2
"Notre Dame la Brune"
LE 30/05 : 09h08 - 13h32 - 17h46



**39ÈME RALLYE NATIONAL DU NOUGAT
DE MONTÉLIMAR DRÔME PROVENÇALE**

29 et 30 mai 2026

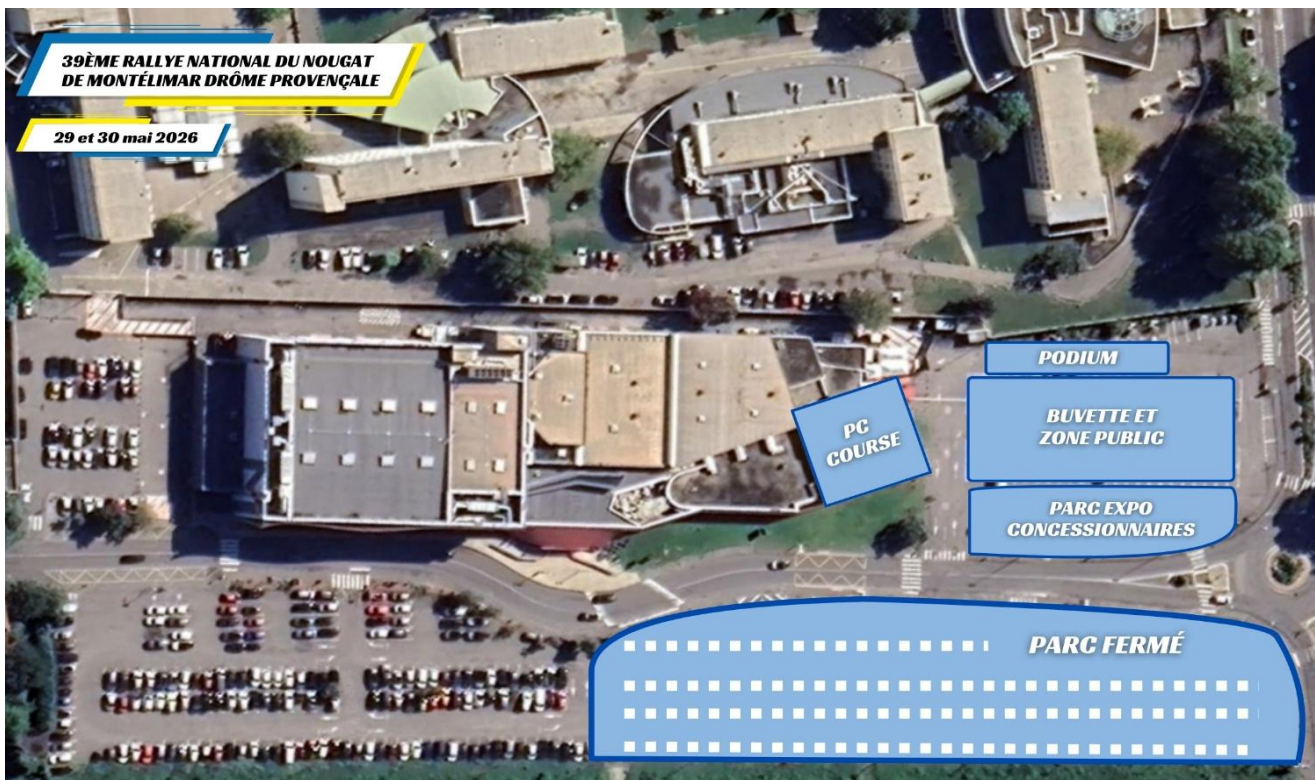

**39ÈME RALLYE NATIONAL DU NOUGAT
DE MONTÉLIMAR DRÔME PROVENÇALE**

29 et 30 mai 2026



IMPORTANT

Mesdames, Messieurs les concurrents,

C'est grâce à la compréhension des Riverains et des Municipalités des communes traversées par le Rallye que l'Association Sportive Automobile de Montélimar a pu organiser cette année les :

- 39^{ème} Rallye National du Nougat de Montélimar Drôme-Provençale**
- 17^{ème} Rallye National V.H.C du Nougat de Montélimar Drôme-Provençale**
- 14^{ème} Rallye National V.H.R.S du Nougat de Montélimar Drôme-Provençale**
- 4^{ème} Rallye National VMRS du Nougat de Montélimar Drôme-Provençale**

C'est cependant grâce à votre sportivité et par l'attitude responsable que vous adopterez lors des reconnaissances du parcours, que la pérennité de l'épreuve pourra être assurée.

Nous vous demandons de **RESPECTER LE CODE DE LA ROUTE**, afin de préserver, la sécurité et la tranquillité des populations et des villages qui vous accueillent, et de suivre scrupuleusement les limitations de vitesse et les horaires réglementés, sur des routes fréquentées par des enfants, allant ou revenant de l'école, et par des véhicules agricoles.

**EN ACCORD AVEC LES SERVICES PREFECTORAUX ET LA GENDARMERIE,
LA REGLEMENTATION SUIVANTE SERA APPLIQUEE :**

Reconnaisances strictement interdites avant le 25 mai 2026

Reconnaisances autorisées uniquement

Le lundi 25 mai 2026 de 9 h 00 à 18 h 30

Le vendredi 29 mai 2026 de 9 h 00 à 18 h 00

Parution du Road Book : www.asamontelimar.com : 21/05/2025

Distribution feuille de reco & panneau de porte : 25/05/2026 et 29/05/2026 8H30

Parking assistance (Autajon Santé Pharmacie à Montélimar)

De plus, dans tous les rallyes asphaltes, le nombre de passages en reconnaissances est limité à 3 au maximum (Art 6.2.1 France Auto 2026)

Limitations de vitesse : **50 Km/h sur les routes des épreuves spéciales.
30 Km/h dans les agglomérations.**

De nombreux contrôles (radars) seront effectués. En sus des procès-verbaux éventuels, des sanctions sportives pouvant aller jusqu'à la mise hors course (refus du départ) sanctionneront les contrevenants sans qu'ils puissent prétendre à un quelconque remboursement des droits d'engagement (conformément au règlement standard des Rallyes français - art 13)

Afin de limiter la gêne des riverains, il vous est demandé :

- ⇒ **De veiller à ce qu'aucune dégradation ne soit apportée à l'environnement, Tous repères, marques, panneaux sont rigoureusement interdits.**
- ⇒ **De ne pas remonter les épreuves spéciales en sens inverse.**











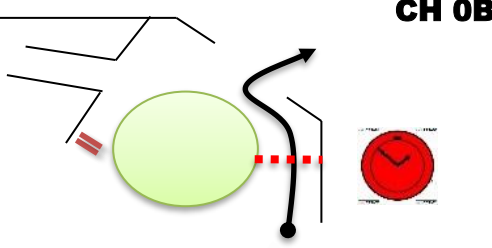
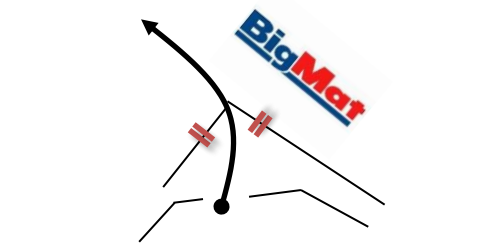

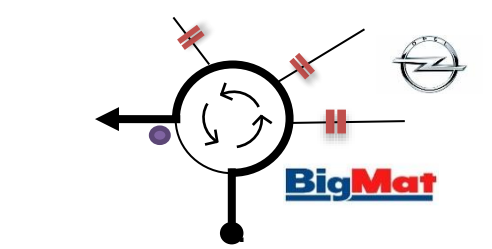

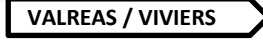
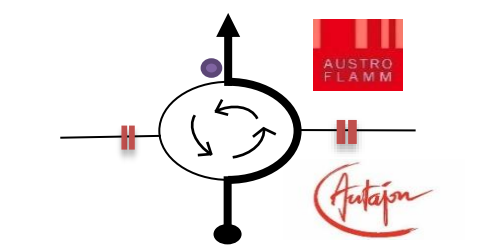

Nous comptons sur votre sportivité, votre courtoisie et votre sens du civisme.

De votre comportement responsable dépend l'avenir des Rallyes

Le comité d'organisation vous souhaite un agréable Rallye du Nougat de Montélimar Drôme-Provençal

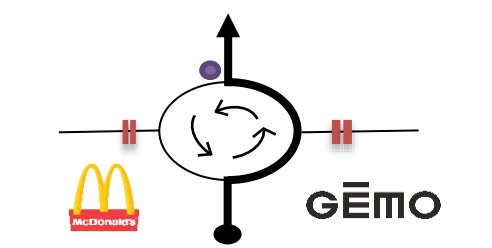
CH		DISTANCE 4,105	TEMPS IMPARTI 10'	Section	Secteur
CH 0	CH 0A			1	1
		MOYENNE 24,6			
DISTANCES		DIRECTION	INFORMATIONS	DEGRESSIF	
TOTAL	PARTIEL				
0,000	0,000		Sortie Parc Fermée A Droite		4,105
0,046	0,046		D540 TOUTES DIRECTIONS CLINIQUE +		4,059
0,538	0,492		D540 TOUTES DIRECTIONS CLINIQUE +		3,567
1,076	0,538		50 N102 ORANGE AUBENAS LE TEIL		3,029
1,407	0,331		N7 AVIGNON NIMES PIERRELATTE NYONS		2,698
2,485	1,078		50 D237 MONTELIMAR CENTRE		1,620

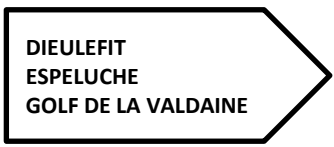
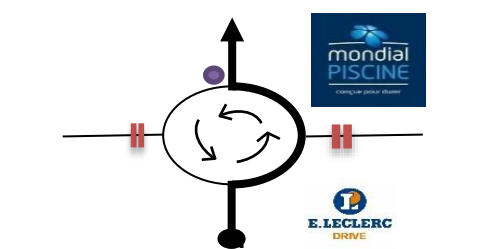
CH		DISTANCE 4,105	TEMPS IMPARTI		Section	Secteur
CH 0	CH 0A		10'		1	1
		MOYENNE 24,6				
DISTANCES		DIRECTION	INFORMATIONS		DEGRESSIF	
TOTAL	PARTIEL					
2,734	0,249		50	ZONE ACTIVITES FORTUNEAU		1,371
2,821	0,087		50	S.I. RUE DE DION BOUTON		1,284
3,686	0,952		50	S.I. VALENCE MONTELMAR-NORD		0,419
3,970	0,284		50	AUTAJON SP		0,135
4,105	0,135		30	ENTREE ASSISTANCE : A MERCI DE RESPECTER L'ENTREPRISE QUI NOUS ACCUEIL		0,000

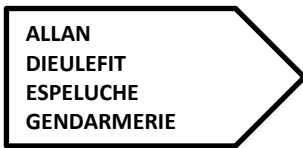
MONTELMAR - ROCHEFORT EN VALDAINE							
CH		DISTANCE	TEMPS		Section	Secteur	
CH 0B	CH 1		15,300	IMPARTI		1	2
		MOYENNE		25'			
DISTANCES		DIRECTION	INFORMATIONS			DEGRESSIF	
TOTAL	PARTIEL						
0,000	0,000		CH 0B SORTIE ASSISTANCE : A			15,300	
0,020	0,020		1		S.I	15,280	
0,100	0,080		2		   	15,200	
0,700	0,600		3		   	14,600	
1,500	0,800		4			13,800	
2,000	0,500		5			13,300	

MONTELMAR - ROCHEFORT EN VALDAINE					
CH		DISTANCE	TEMPS		Section
CH 0B	CH 1		15,300	IMPARTI	1
		MOYENNE		25'	
		36,72			
DISTANCES		DIRECTION	INFORMATIONS		DEGRESSIF
TOTAL	PARTIEL				
2,400	0,400		ZONE DE CHANTIER		12,900
3,100	0,700		DIEULEFIT ESPELUCHE GENDARMERIE		12,200
3,600	0,500		DIEULEFIT ESPELUCHE		11,700
4,000	0,400		ESPELUCHE GOLF DE LA VALDAINE		11,300
6,700	2,700		MONTBOUCHER GOLF DE LA VALDAINE		8,600
8,000	1,300		LA BATIE ROLLAND LA BEGUDE DE M. DIEULEFIT DECHETTERIE		7,300

MONTELMAR - ROCHEFORT EN VALDAINE							
CH		DISTANCE	TEMPS		Section	Secteur	
CH 0B	CH 1		15,300	IMPARTI		1	2
		MOYENNE		25'			
DISTANCES		DIRECTION	INFORMATIONS			DEGRESSIF	
TOTAL	PARTIEL						
9,500	1,500				12	5,800	
11,200	1,700			 	13	4,100	
11,500	0,300			 	14	3,800	
11,750	0,250			 	15	3,550	
15,000	3,250			 	16	0,300	
15,300	0,300		CH 1 		17	0,000	

ES 1

Rochefort en Valdaine

* JP Tacussel *

12,350 Kms

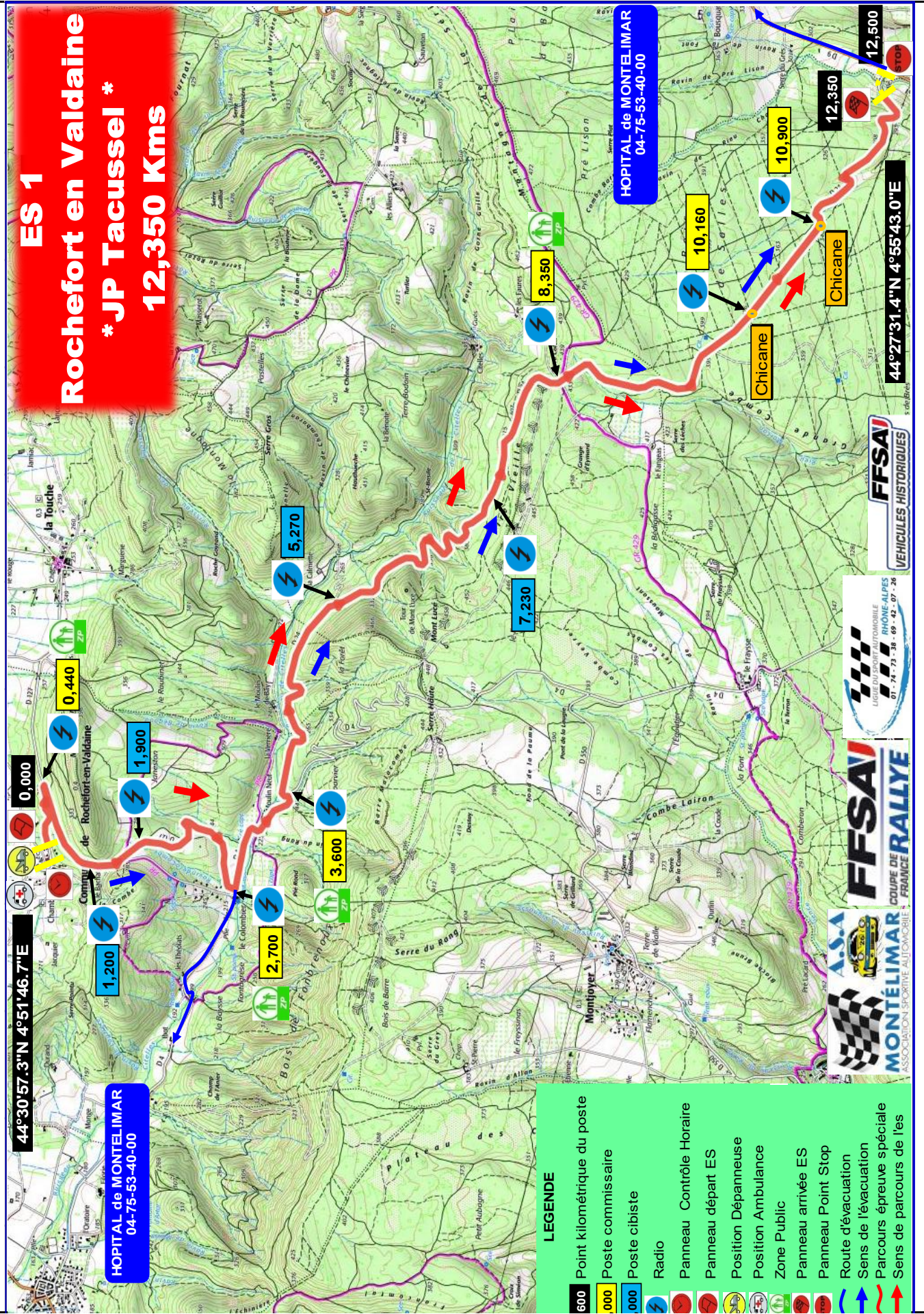

44°30'57.3"N 4°51'46.7"E

HOPITAL de MONTELMAR
04-75-53-40-00

HOPITAL de MONTELMAR
04-75-53-40-00

44°27'31.4"N 4°55'43.0"E

- #### LEGENDE
- 600 Point kilométrique du poste
 - 000 Poste commissaire
 - 000 Poste cibiste
 - Radio
 - Panneau Contrôle Horaire
 - Panneau départ ES
 - Position Dépanneuse
 - Position Ambulance
 - Zone Public
 - Panneau arrivée ES
 - Panneau Point Stop
 - Route d'évacuation
 - Sens de l'évacuation
 - Parcours épreuve spéciale
 - Sens de parcours de l'es

FFSAI
VEHICULES HISTORIQUES

FFSAI
LEADER NATIONAL PHONIE ALPES
01-74-73-38-69 - 02-07-26











FFSAI
COUPE DE FRANCE RALLYE

ASA
MONTÉLMAR
ASSOCIATION SPORTIVE AUTOMOBILE

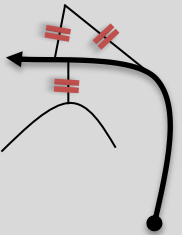
ROCHFORT EN VALDAINE - SALLES SOUS BOIS

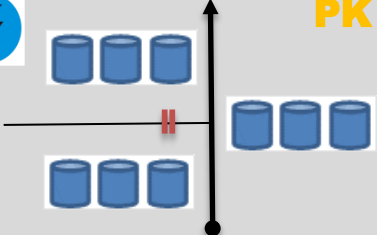

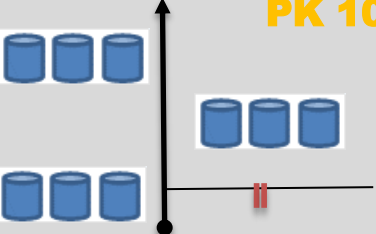
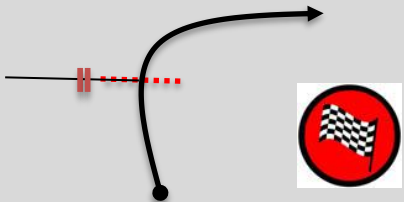
DES		CH	DISTANCE	TEMPS	Section	Secteur
DES 1	CH 2		14,200	IMPARTI	1	3
			MOYENNE	20'		
DISTANCES		DIRECTION			INFORMATIONS	
TOTAL	PARTIEL				DEGRESSIF	
0,000	0,000	<p>DES 1</p>				
0,440	0,440	<p>PK 4</p>			<p>D127</p> <p>COLOMBIER MONTELIMAR</p>	
1,200	0,760	<p>PK 12</p>			<p>D127</p> <p>S.R.P</p>	
1,900	0,700	<p>PK 19</p>			<p>D127</p> <p>S.R.P</p>	
2,700	0,800	<p>PK 27</p>			<p>ZONE</p> <p>30</p> <p>!! TRES ETROIT !!</p> <p>D4</p> <p>LE COLOMBIER</p>	
3,600	0,900	<p>PK 36</p>			<p>D24</p> <p>TAULIGNAN NYONS</p>	

ROCHFORT EN VALDAINE - SALLES SOUS BOIS

DES		CH	DISTANCE	TEMPS	Section	Secteur
DES 1	CH 2		14,200	IMPARTI	1	3
			MOYENNE	20'		
DISTANCES		DIRECTION			INFORMATIONS	
TOTAL	PARTIEL				DEGRESSIF	
5,270	1,670		 PK 52	7	S.R.P CHEMIN A GAUCHE	8,930
7,230	1,960		 PK 72	8	S.R.P CHEMIN A DROITE	6,970
8,350	1,120		 PK 83	9	S.R.P CHEMIN A DROITE ET A GAUCHE	5,850
10,160	1,810		 PK 101	11	ATTENTION CHICANE FUTS PLEINS Entrée a droite !!!!!!	4,040
10,900	0,740		 PK 109	12	ATTENTION CHICANE FUTS PLEINS Entrée a droite !!!!!!	3,300
12,350	1,450		 AES 1	13		1,850

ROCHFORT EN VALDAINE - SALLES SOUS BOIS

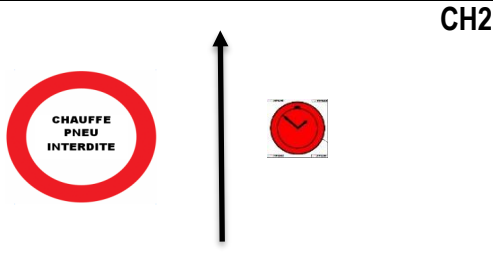
DES		CH	DISTANCE	TEMPS	Section	Secteur
DES 1	CH 2		14,200	IMPARTI	1	3
			MOYENNE 42,6	20'		
DISTANCES		DIRECTION			INFORMATIONS	
TOTAL	PARTIEL				DEGRESSIF	
12,500	0,150					1,700
12,500	0,000				<p>D24</p> <p>SALLES SOUS BOIS TAULIGNAN</p>	1,700
13,300	0,800				<p>D24</p> <p>SALLES SOUS BOIS TAULIGNAN</p> <p>SALLES SOUS BOIS</p>	0,900
13,400	0,100				<p>50</p> <p>D24</p> <p>S.I / S.R.P</p>	0,800
13,800	0,400				<p>50</p> <p>D24</p> <p>S.I / S.R.P</p>	0,400
13,950	0,150				<p>CHEMIN SAINT DENIS</p>	0,250

ROCHFORT EN VALDAINE - SALLES SOUS BOIS						
DES		CH	DISTANCE	TEMPS		
DES 1	CH 2		14,200	IMPARTI		
			MOYENNE	20'		
			42,6			
DISTANCES		DIRECTION		INFORMATIONS		
TOTAL	PARTIEL			DEGRESSIF		
14,200	0,250			<p>CH2</p> 		0,000



HOPITAL de MONTÉLIMAR
04-75-53-40-00



ES 2-3-6-9 Salles - Aleyrac "Notre Dame la Brune" 8,099 Kms

44°29'42.7"N 4°56'23.9"E

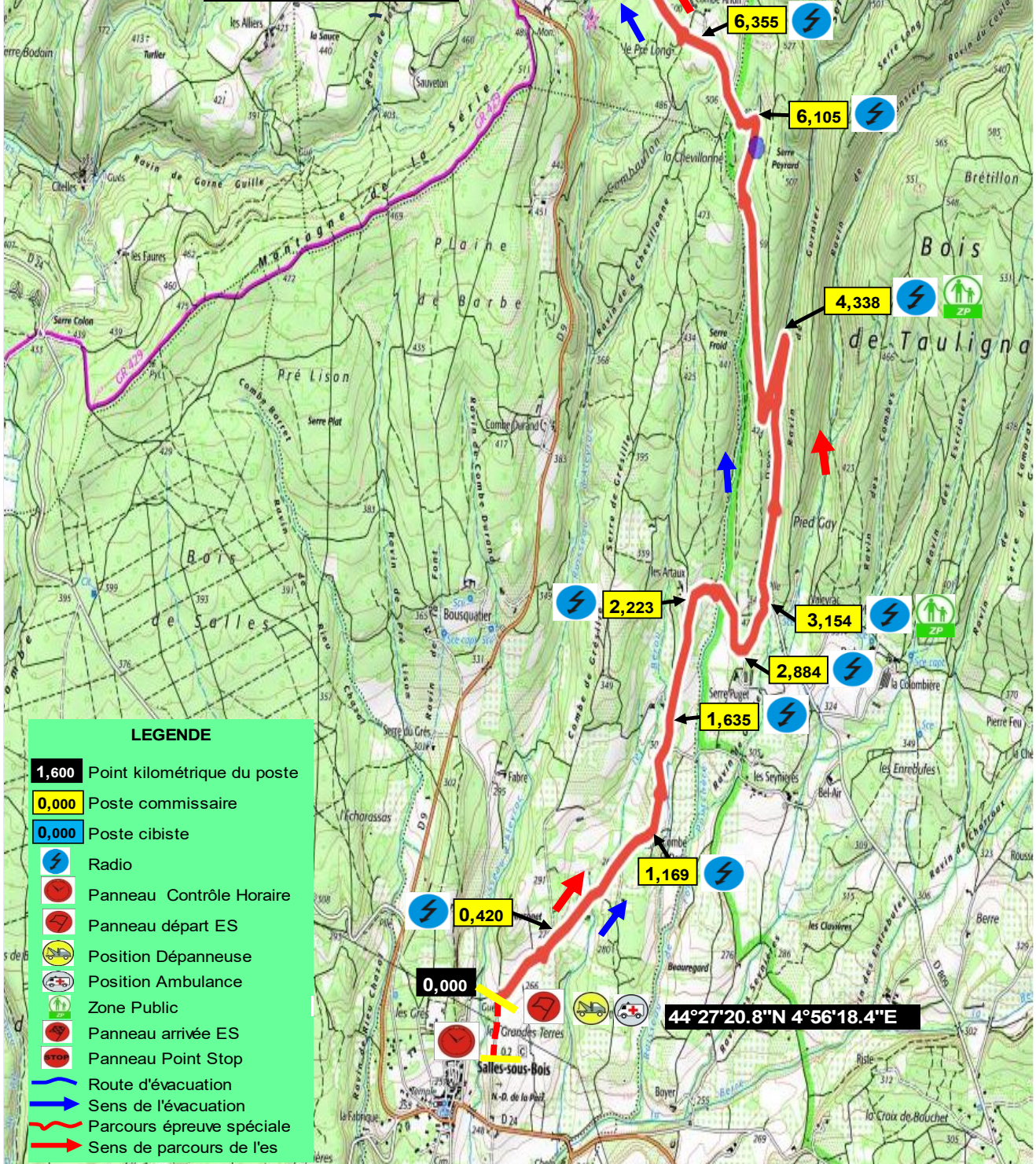









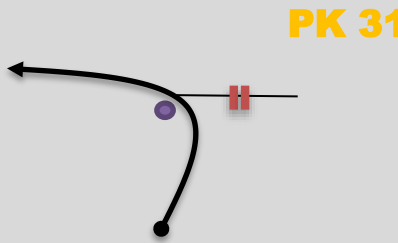

- LEGENDE**
- 1,600 Point kilométrique du poste
 - 0,000 Poste commissaire
 - 0,000 Poste cibiste
 - Radio
 - Panneau Contrôle Horaire
 - Panneau départ ES
 - Position Dépanneuse
 - Position Ambulance
 - Zone Public
 - Panneau arrivée ES
 - Panneau Point Stop
 - Route d'évacuation
 - Sens de l'évacuation
 - Parcours épreuve spéciale
 - Sens de parcours de l'es

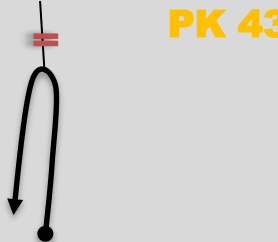
44°27'20.8"N 4°56'18.4"E

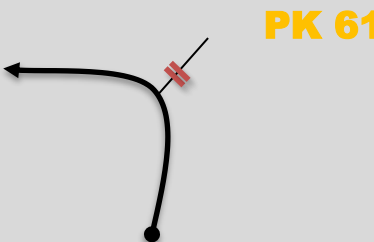
SALLES-SOUS-BOIS - MONTELIMAR

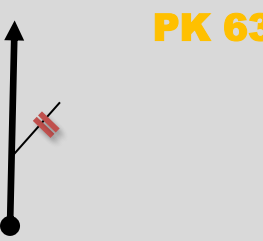
DES		CH	DISTANCE	TEMPS	Section	Secteur
DES 2	CH 2A		32,400	IMPARTI	1	4
			MOYENNE 38,88	50'		
DISTANCES		DIRECTION			INFORMATIONS	
TOTAL	PARTIEL				DEGRESSIF	
0,000	0,000					32,4
0,420	0,420			PK 4 S.R.P Route a gauche (panneau les lapins de bastien)	31,980	
1,169	0,749			PK 11 Double chemin a droite	31,231	
1,635	0,466			PK 16 S.R.P Route a droite	30,765	
2,335	0,700			PK 23 Route a gauche	30,065	
2,884	0,549			PK 28 S.R.P Route a droite	29,516	

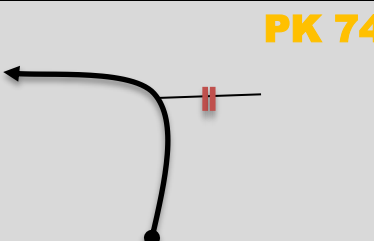
SALLES-SOUS-BOIS - MONTELMAR

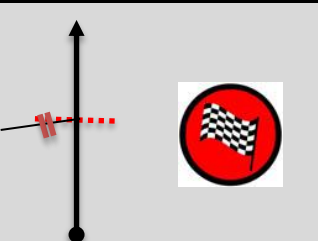
DES		CH	DISTANCE	TEMPS	Section	Secteur
DES 2	CH 2A		32,400	IMPARTI	1	4
			MOYENNE 38,88	50'		
DISTANCES		DIRECTION			INFORMATIONS	
TOTAL	PARTIEL				DEGRESSIF	
3,154	0,270	  PK 31	 Reprise route principale	7		29,246
4,338	1,184	  PK 43	S.R.P Chemin en face	8		28,062
6,105	1,767	  PK 61	S.R.P Chemin a droite	9		26,295
6,355	0,250	  PK 63	S.R.P Chemin de Rialhe	10		26,045
7,492	1,137	  PK 74	S.R.P CHEMIN A DROITE	11		24,908
8,099	0,607	  PK 74	S.R.P CHEMIN GAUCHE	12		24,301

SALLES-SOUS-BOIS - MONTELIMAR

DES		CH	DISTANCE	TEMPS	Section	Secteur
DES 2	CH 2A		32,400	IMPARTI	1	4
			MOYENNE	50'		
DISTANCES		DIRECTION		INFORMATIONS		DEGRESSIF
TOTAL	PARTIEL					
8,335	0,236			13	24,065	
8,386	0,051			14	24,014	
14,500	6,114			15	17,900	
14,950	0,450			16	17,450	
15,750	0,800			17	16,650	
20,250	4,500			18	12,150	

SALLES-SOUS-BOIS - MONTELMAR

DES		CH	DISTANCE	TEMPS	Section	Secteur
DES 2	CH 2A		32,400	IMPARTI	1	4
			MOYENNE	50'		
DISTANCES		DIRECTION			INFORMATIONS	
TOTAL	PARTIEL				DEGRESSIF	
21,750	1,500			19		10,650
24,000	2,250			20		8,400
25,400	1,400			21		7,000
25,550	0,150			22		6,850
26,750	1,200			23		5,650
29,500	2,750			24		2,900

SALLES-SOUS-BOIS - MONTELMAR

DES		CH	DISTANCE	TEMPS	Section	Secteur	
DES 2	CH 2A		32,400	IMPARTI	1	4	
			MOYENNE	50'			
DISTANCES		DIRECTION			INFORMATIONS		
TOTAL	PARTIEL				DEGRESSIF		
30,700	1,200				50	S.I	1,700
30,850	0,150				50	D56 MONTELMAR CENTRE	1,550
31,650	0,800				50	D540A S.I	0,750
31,900	0,250				50	D540 TOUTES DIRECTIONS CLINIQUE PALAIS DES CONGRES	0,500
32,300	0,400				50	GARE SNCF PALAIS DES CONGRES	0,100
32,400	0,100	CH2A 			30	A DROITE Entrée du parc fermée PARKING PALAIS DES CONGRES	0,000

COUPE DE FRANCE DES RALLYES PEA COEF. 3

FFSA

39EME RALLYE DU NOUGAT

DE MONTELMAR DROME PROVENCE

17EME VHC 14EME VHRS 4EME VMRS

**ROAD-BOOK
MODERNE ET VHC**



29 ET 30 MAI 2026











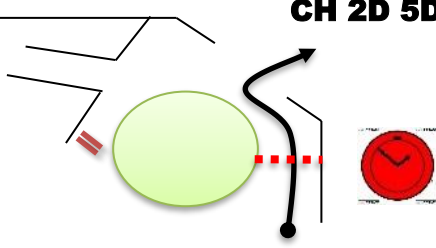
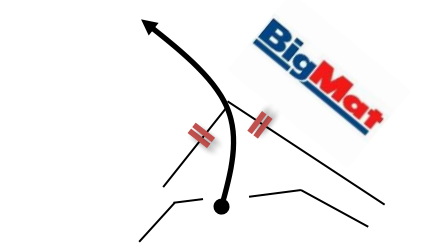
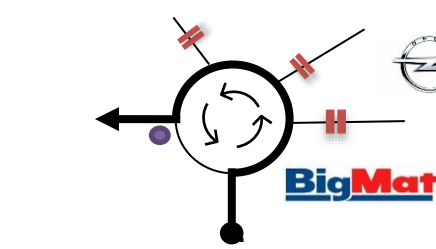
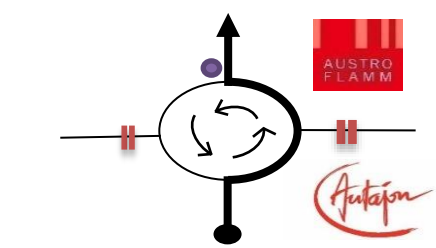
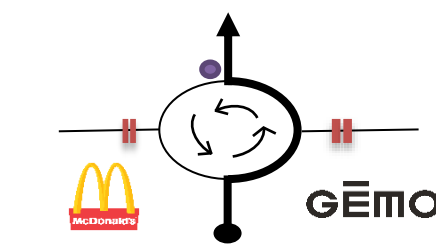
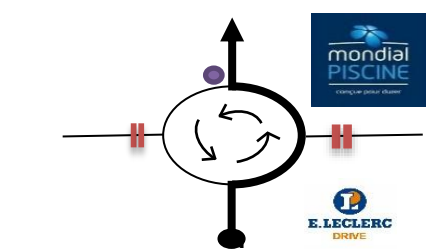

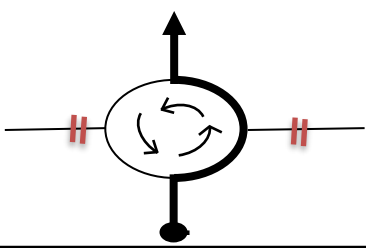

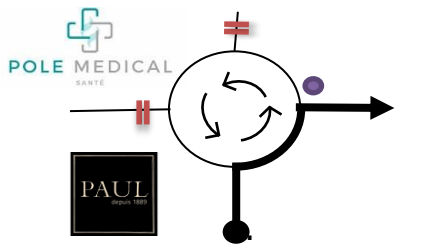
SAMEDI

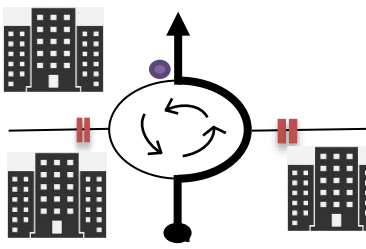
MONTELMAR - MONTELMAR						
CH		DISTANCE	TEMPS		Section	Secteur
CH 2B	CH 2C	4,105	IMPARTI		2	5
CH 5B	CH 5C	MOYENNE	10'		3	10
CH8B	CH8C	24,6			4	15
DISTANCES		DIRECTION	INFORMATIONS			DEGRESSIF
TOTAL	PARTIEL					
0,000	0,000	<p>CH 2B 5B 8B</p>	<p>Sortie Parc Fermée A Droite</p>			4,105
0,046	0,046		<p>1</p>			4,059
0,538	0,492		<p>2</p>			3,567
1,076	0,538		<p>3</p>			3,029
1,407	0,331		<p>4</p>			2,698
2,485	1,078		<p>5</p>			1,620
			<p>6</p>			

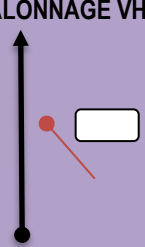

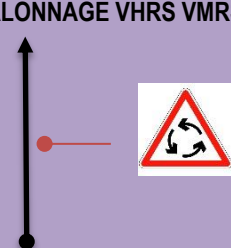

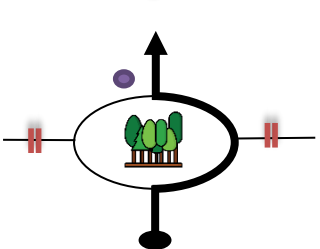





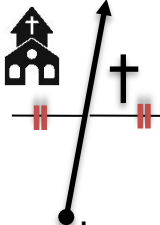

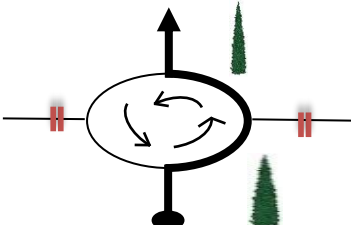

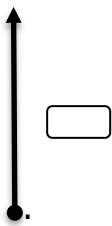

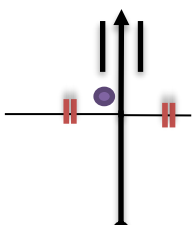
MONTELMAR - MONTELMAR						
CH		DISTANCE	TEMPS		Section	Secteur
CH 2B	CH 2C	4,105	IMPARTI		2	5
CH 5B	CH 5C	MOYENNE	10'		3	10
CH8B	CH8C	24,6			4	15
DISTANCES		DIRECTION	INFORMATIONS			DEGRESSIF
TOTAL	PARTIEL					
2,734	0,249		50	ZONE ACTIVITES FORTUNEAU		1,371
2,821	0,087		50	S.I. RUE DE DION BOUTON		1,284
3,686	0,952		50	S.I. VALENCE MONTELMAR-NORD		0,419
3,970	0,284		50	AUTAJON SP		0,135
4,105	0,135		30	ENTREE ASSISTANCE : A B C D MERCI DE RESPECTER L'ENTREPRISE QUI NOUS ACCUEIL		0,000

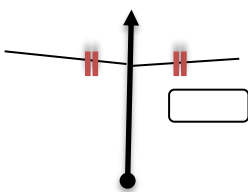
MONTELMAR - SALLES SOUS BOIS



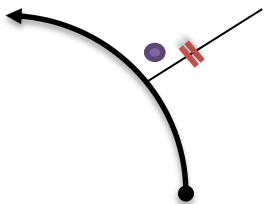







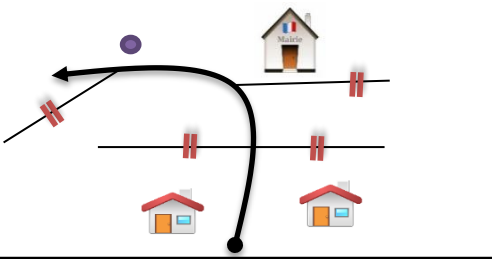



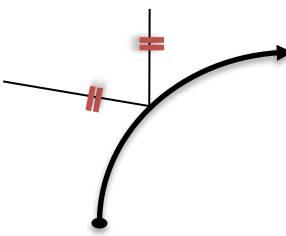
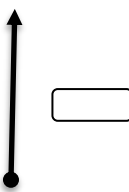

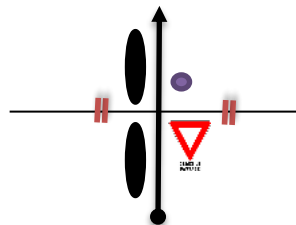
CH		DISTANCE	TEMPS	Section	Secteur
CH 2D	CH 3	30,546	IMPARTI	2	6
CH 5D	CH 6	MOYENNE	40'	3	11
CH 8D	CH 9	42,9		4	16
DISTANCES		DIRECTION	INFORMATIONS		
TOTAL	PARTIEL				
		CH 2D 5D 8D	SORTIE ASSISTANCE : B C D		
0,000	0,000		1	50	30,546
0,020	0,020		2	S.I	30,526
0,108	0,088		3	70 N7 A7 GAP / ORANGE / NIMES VALREAS / VIVIERS	30,438
0,873	0,765		4	50 N7 A7 GAP / ORANGE / NIMES VALREAS / DIEULEFIT	29,673
1,563	0,690			50 DIEULEFIT ESPELUCHE GOLF DE LA VALDAINE	28,983
2,146	0,583		6	70 ALLAN DIEULEFIT ESPELUCHE GENDARMERIE	28,400

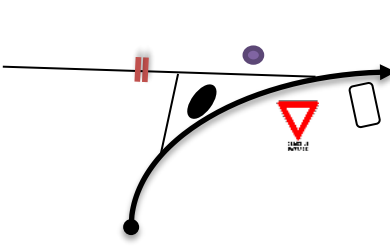

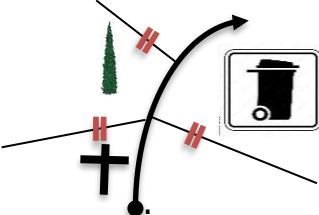

MONTELIMAR - SALLES SOUS BOIS							
CH		DISTANCE		TEMPS		Section	Secteur
CH 2D	CH 3	30,546		IMPARTI		2	6
CH 5D	CH 6	MOYENNE		40'		3	11
CH 8D	CH 9	42,9				4	16
DISTANCES		DIRECTION		INFORMATIONS			
TOTAL	PARTIEL						
X	x				ZONE DE CHANTIER		x
3,339	1,193			7			27,207
3,693	0,354			8			26,853
3,804	0,111	DEBUT ZONE ETALONNAGE VHRS VMRS 		9			26,742
8,264	4,460	FIN DE ZONE ETALONNAGE VHRS VMRS 		10			22,282
8,420	0,156			11			22,126

MONTELMAR - SALLES SOUS BOIS

CH		DISTANCE	TEMPS IMPARTI	Section	Secteur
CH 2D	CH 3			30,546	2
CH 5D		MOYENNE	42,9	3	11
CH 8D				4	16
DISTANCES		DIRECTION	INFORMATIONS		
TOTAL	PARTIEL				
8,901	0,481		 En face S.I 12 	21,645	
9,213	0,312		 S.R.P S.I 13	21,333	
9,409	0,196		  S.R.P pendant 8,5 KM 14	21,137	
18,468	9,059		  15	12,078	
20,171	1,703		   16 	10,375	
20,534	0,363		   17 	10,012	

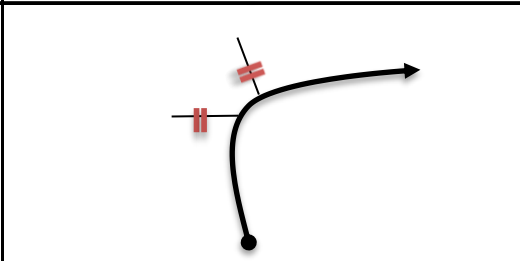
MONTELMAR - SALLES SOUS BOIS

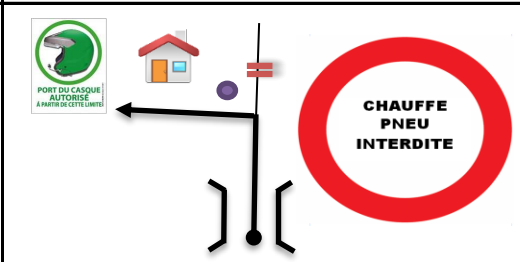
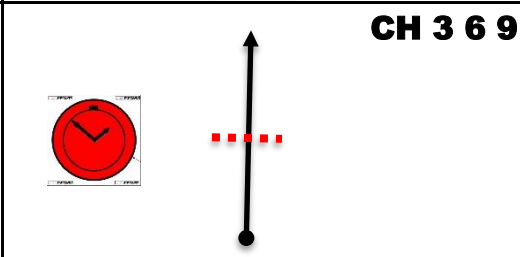
CH		DISTANCE	TEMPS	Section	Secteur
CH 2D	CH 3	30,546	IMPARTI	2	6
CH 5D	CH 6	MOYENNE	40'	3	11
CH 8D	CH 9	42,9		4	16
DISTANCES		DIRECTION	INFORMATIONS		
TOTAL	PARTIEL				
20,616	0,082		  S.R.P 	18	9,93
20,907	0,291		S.R.P	19	9,639
24,719	3,812		  S.R.P	20	5,827
26,462	1,743		 	21	4,084
29,561	3,099		   	22	0,985
29,732	0,171		  S.I / S.R.P 	23	0,814

MONTELIMAR - SALLES SOUS BOIS						
CH		DISTANCE	TEMPS		Section	Secteur
CH 2D	CH 3	30,546	IMPARTI		2	6
CH 5D	CH 6	MOYENNE	40'		3	11
CH 8D	CH 9	42,9			4	16
DISTANCES		DIRECTION		INFORMATIONS		
TOTAL	PARTIEL					
30,002	0,270			S.I / S.R.P 	0,544	
30,196	0,194			CHEMIN SAINT DENIS	0,350	
30,546	0,350				0,000	



HOPITAL de MONTÉLIMAR
04-75-53-40-00



ES 2-3-6-9
Salles - Aleyrac
"Notre Dame la Brune"
8,099 Kms

44°29'42.7"N 4°56'23.9"E

8,099

7,492

8,335

6,355

6,105

4,338

2,223

3,154

2,884

1,635

1,169

0,420

44°27'20.8"N 4°56'18.4"E

- LEGENDE**
- 1,600 Point kilométrique du poste
 - 0,000 Poste commissaire
 - 0,000 Poste cibiste
 - Radio
 - Panneau Contrôle Horaire
 - Panneau départ ES
 - Position Dépanneuse
 - Position Ambulance
 - Zone Public
 - Panneau arrivée ES
 - Panneau Point Stop
 - Route d'évacuation
 - Sens de l'évacuation
 - Parcours épreuve spéciale
 - Sens de parcours de l'es

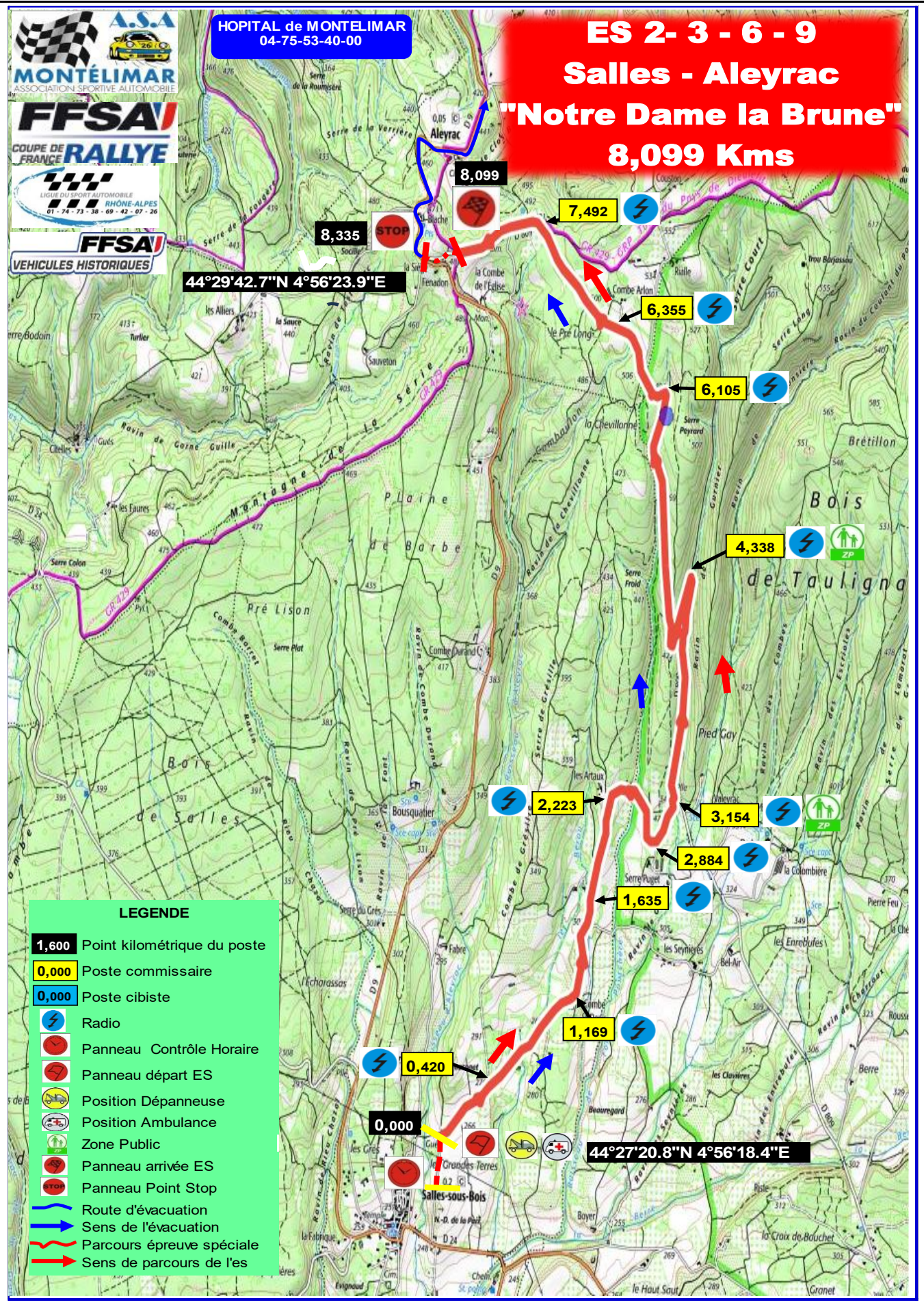

SALLES-SOUS-BOIS - SALLES SOUS BOIS						
CH		DISTANCE	TEMPS		Section	Secteur
DES 3	CH 4	13,559	IMPARTI		2	7
DES 6	CH 5	MOYENNE 41,2	20'		3	12
DES 9	CH 6				4	17
DISTANCES		DIRECTION	INFORMATIONS			DEGRESSIF
TOTAL	PARTIEL					
0,000	0,000					13,559
0,420	0,420			S.R.P Route a gauche (panneau les lapins de bastien)		13,139
1,169	0,749			Double chemin a droite		12,390
1,635	0,466			S.R.P Route a droite		11,924
2,335	0,700			Route a gauche		11,224
2,884	0,549			S.R.P Route a droite		10,675

SALLES-SOUS-BOIS - SALLES SOUS BOIS						
CH	CH	DISTANCE	TEMPS		Section	Secteur
DES 3	CH 4	13,559	IMPARTI		2	7
DES 6	CH 5	MOYENNE 41,2	20'		3	12
DES 9	CH 6				4	17
DISTANCES		DIRECTION	INFORMATIONS			DEGRESSIF
TOTAL	PARTIEL					
3,154	0,270	<p>PK 31</p>	<div style="border: 1px solid black; border-radius: 10px; padding: 5px; text-align: center;"> CHEMIN DU SERRE PUGET </div> <p>Reprise route principale</p>	7	10,405	
4,338	1,184	<p>PK 43</p>	S.R.P Chemin en face	8	9,221	
6,105	1,767	<p>PK 61</p>	S.R.P Chemin a droite	9	7,454	
6,355	0,250	<p>PK 63</p>	S.R.P Chemin de Rialhe	10	7,204	
7,492	1,137	<p>PK 74</p>	S.R.P CHEMIN A DROITE	11	6,067	
8,099	0,607		<p>S.R.P CHEMIN GAUCHE</p>	12	5,460	

SALLES-SOUS-BOIS - SALLES SOUS BOIS						
CH		DISTANCE	TEMPS		Section	Secteur
DES 3	CH 4	13,559	IMPARTI		2	7
DES 6	CH 5	MOYENNE	20'		3	12
DES 9	CH 6	41,2			4	17
DISTANCES		DIRECTION	INFORMATIONS			
TOTAL	PARTIEL		DEGRESSIF			
8,335	0,236			13	5,224	
8,386	0,051			14	5,173	
13,406	5,020			15	0,153	
13,559	0,153			16	0,000	

ES 4 - 7 - 10

LE COLOMBIER

J.P Mauveaux

13,376Kms

HOPITAL de MONTELMAR
04-75-53-40-00



LEGENDE



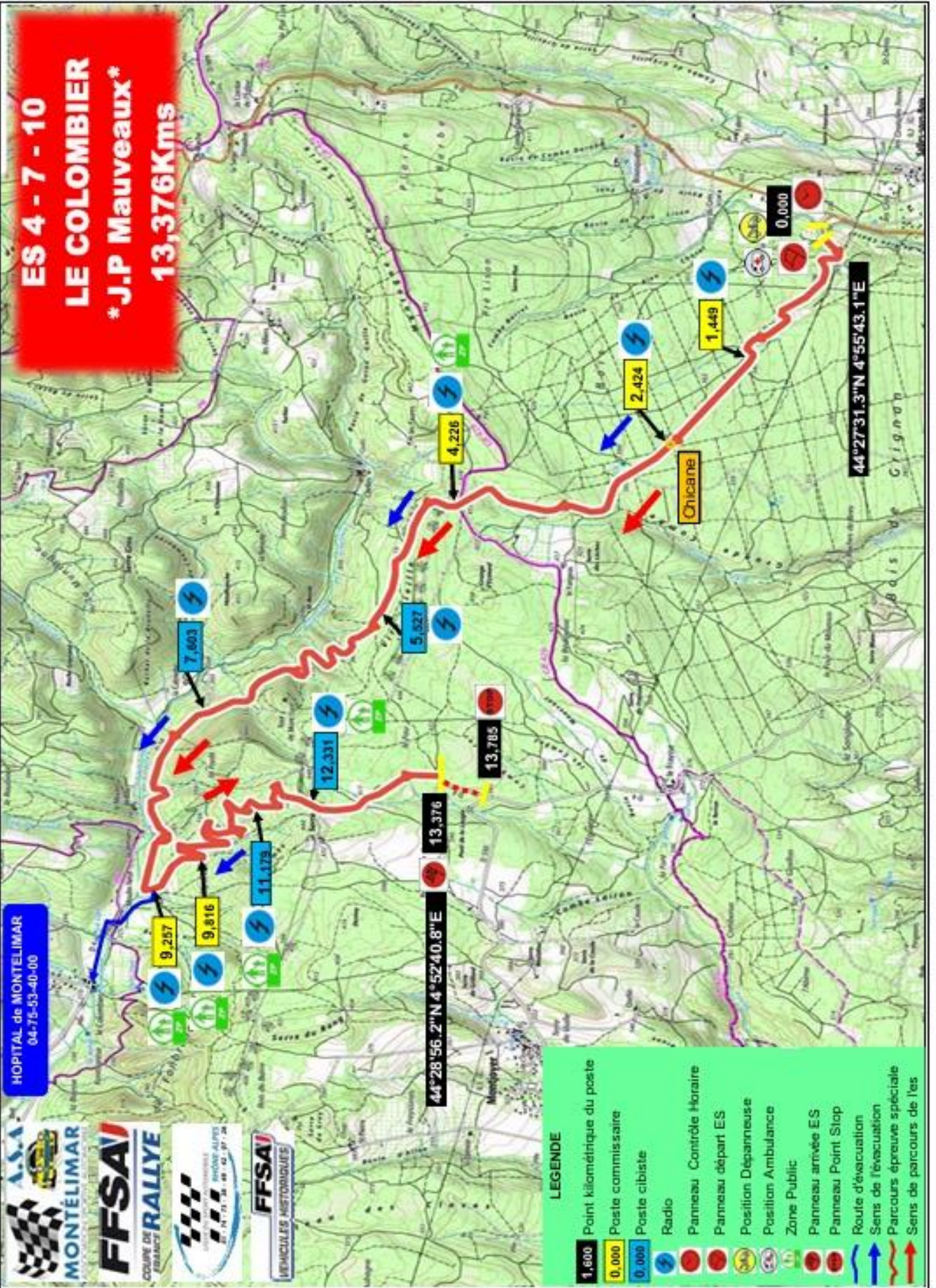







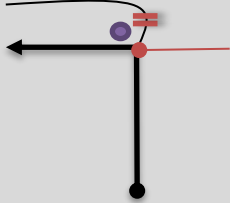



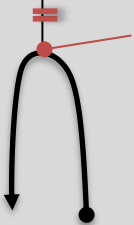

- 1,600 Point kilométrique du poste
- 0,000 Poste commissaire
- 0,000 Poste cibiste
- Radio
- Panneau Contrôle Horaire
- Panneau départ ES
- Position Départeuse
- Position Ambulance
- Zone Public
- Panneau arrivée ES
- Panneau Point Stop
- Route d'évacuation
- Sens de l'évacuation
- Parcours épreuve spéciale
- Sens de parcours de l'es

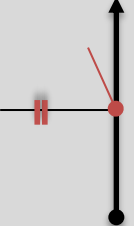

SALLES SOUS BOIS - MONTSEGUR SUR LAUZON

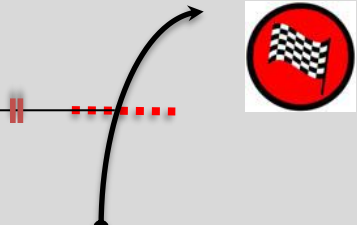
DES		CH	DISTANCE	TEMPS	Section	Secteur
DES 4		CH 5	31,888	IMPARTI	2	8
DES 7		CH 8	MOYENNE 47,8	40'	3	13
DES 10		CH 11			4	18
DISTANCES		DIRECTION		INFORMATIONS		DEGRESSIF
TOTAL	PARTIEL					
0,000	0,000	<p align="right">DES 4 7 10</p>				31,888
1,449	1,449	<p align="right">PK 14</p>		VO Terre a droite		30,439
2,424	0,975	<p align="right">PK 24</p>		ENTREE A DROITE FUTS PLEINS Chicane 50M Après Panneau		29,464
4,226	1,802	<p align="right">EOLIENNES PK 42</p>		Place a droite S.R.P S.I		27,662
5,527	1,301	<p align="right">PK 55</p>		S.R.P S.I		26,361
7,603	2,076	<p align="right">PK 76</p>		S.R.P S.I		24,285

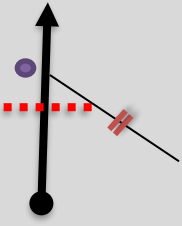
SALLES SOUS BOIS - MONTSEGUR SUR LAUZON

DES		CH	DISTANCE	TEMPS		Section	Secteur
DES 4		CH 5	31,888	IMPARTI		2	8
DES 7		CH 8	MOYENNE 47,8	40'		3	13
DES 10		CH 11				4	18
DISTANCES		DIRECTION		INFORMATIONS		DEGRESSIF	
TOTAL	PARTIEL						
9,257	1,654			PK 92	 		22,631
9,816	0,559			PK 98	 S.R.P S.I		22,072
11,179	1,363			PK 111	 S.R.P S.I		20,709
12,331	1,152			PK 1123	 		19,557
13,376	1,045						18,512
13,785	0,409				 		18,103

SALLES SOUS BOIS - MONTSEGUR SUR LAUZON

DES		CH	DISTANCE	TEMPS	Section	Secteur
DES 4		CH 5	31,888	IMPARTI	2	8
DES 7		CH 8	MOYENNE 47,8	40'	3	13
DES 10		CH 11			4	18
DISTANCES		DIRECTION		INFORMATIONS		DEGRESSIF
TOTAL	PARTIEL					
20,040	6,255			<p>D4</p> <p>GRIGNAN</p>		11,848
20,975	0,935			<p>TOUTES DIRECTIONS</p> <p>! PEU VISIBLE !</p>		10,913
22,584	1,609			<p>D71</p> <p>CHAMARET</p> <p>MONTSEGUR S/ L. ST PAUL 3 CHX</p>		9,304
25,042	2,458			<p>50</p> <p>D71</p> <p>CHAMARET</p>		6,846
25,684	0,642			<p>50</p> <p>D71</p> <p>MONSEGUR SUR LAUZON</p> <p>ST PAUL-TROIS CHATEAUX</p>		6,204
29,935	4,251			<p>50</p> <p>D71</p> <p>MONSEGUR SUR LAUZON</p>		1,953

SALLES SOUS BOIS - MONTSEGUR SUR LAUZON

DES		CH	DISTANCE	TEMPS	Section	Secteur
DES 4		CH 5	31,888	IMPARTI	2	8
DES 7		CH 8	MOYENNE 47,8	40'	3	13
DES 10		CH 11			4	18
DISTANCES		DIRECTION		INFORMATIONS		DEGRESSIF
TOTAL	PARTIEL					
30,422	0,487			D71 SAINT PAUL 3 CHX PIERRELATTE		1,466
30,778	0,356			D481 CLANSAYES		1,110
31,648	0,870			D481 PORT DU CASQUE AUTORISÉ À PARTIR DE CETTE LIMITE!		0,240
31,888	0,240			D481 		0,000



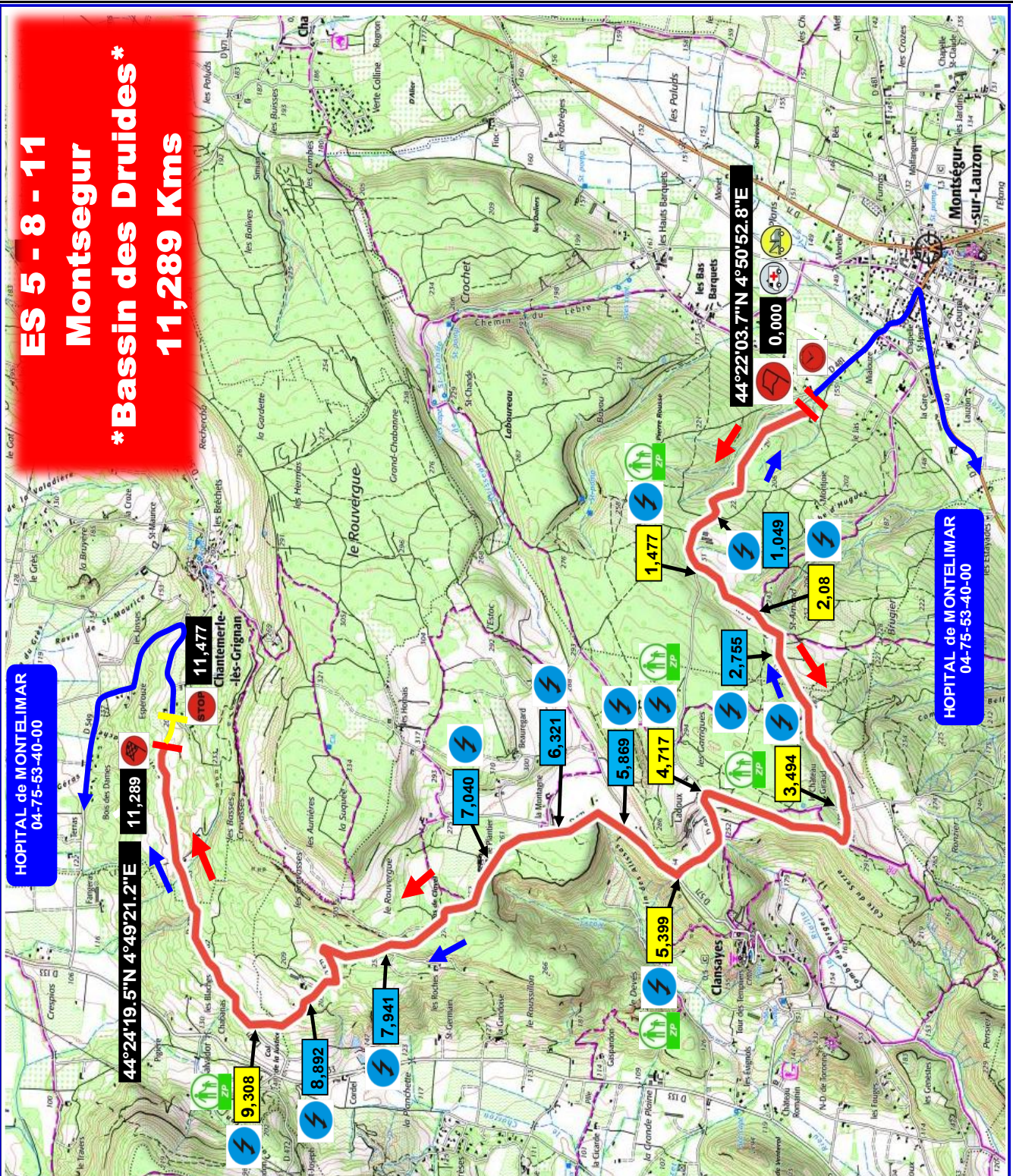







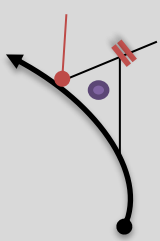



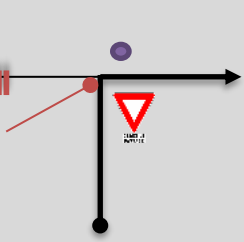

ES 5 - 8 - 11 Montsegur * Bassin des Druides * 11,289 Kms

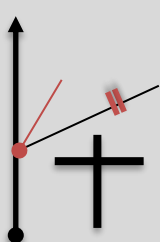

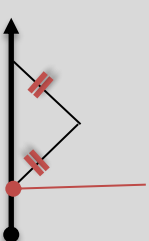

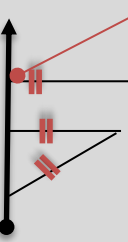

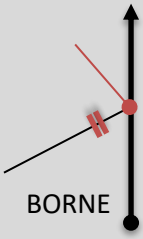



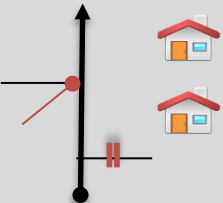

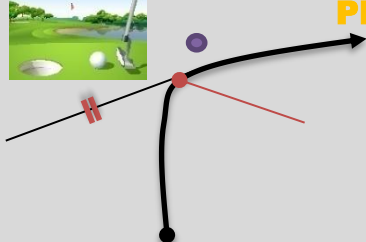

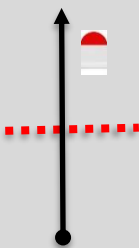

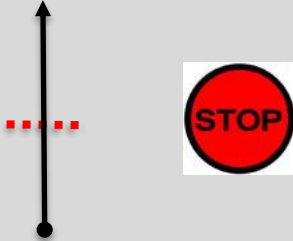

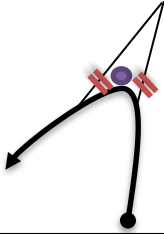

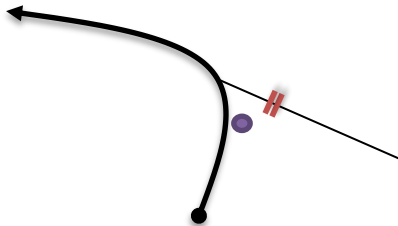
LEGENDE

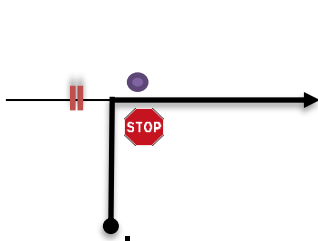

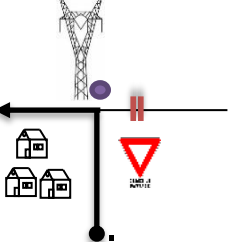
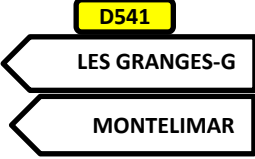
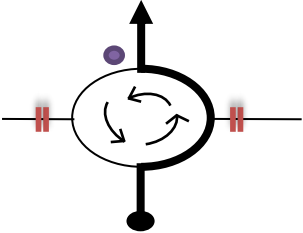

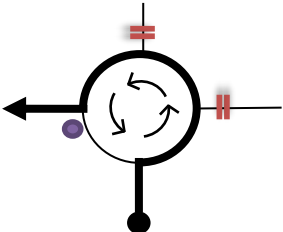

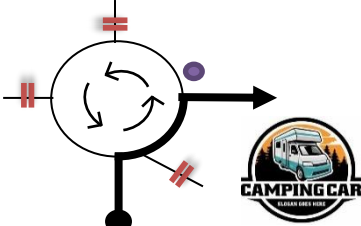
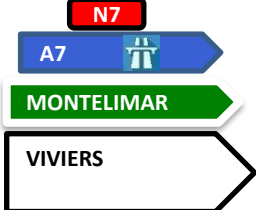
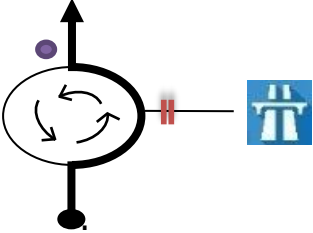



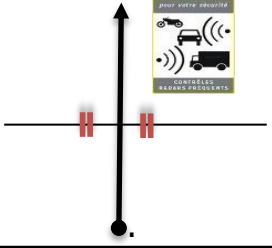
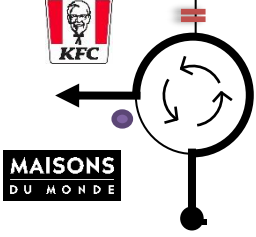

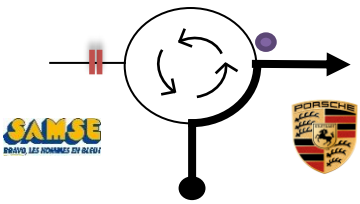
- 1,600 Point kilométrique du poste
- 0,000 Poste commissaire
- 0,000 Poste cibiste
- Radio
- Panneau Contrôle Horaire
- Panneau départ ES
- Position Dépanneuse
- Position Ambulance
- Zone Public
- Panneau arrivée ES
- Panneau Point Stop
- Route d'évacuation
- Sens de l'évacuation
- Parcours éprouve spéciale
- Sens de parcours de l'es

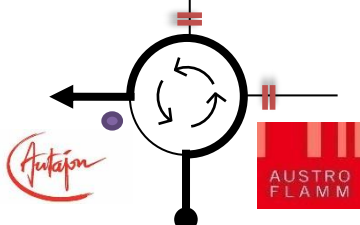
MONTSEGUR SUR LAUZON - MONTELMAR						
CH		DISTANCE	TEMPS		Section	Secteur
DES 5	CH 5A	38,411	IMPARTI		2	9
DES 8	CH 8A	MOYENNE	45'		3	14
DES 11	CH 11A	48			4	19
DISTANCES		DIRECTION		INFORMATIONS		DEGRESSIF
TOTAL	PARTIEL					
0,000	0,000	DES 5 8 11		D481		38,410
1,049	1,049	PK 10		D481 S.R.P S.I		37,361
1,477	0,428	PK 14		CLANSAYES		36,933
2,100	0,623	PK 24		S.R.P S.I Chemin a gauche		36,310
2,755	1,278	PK 27		D481 S.R.P S.I		35,655
3,494	0,739	PK 34		CLANSAYES		34,916

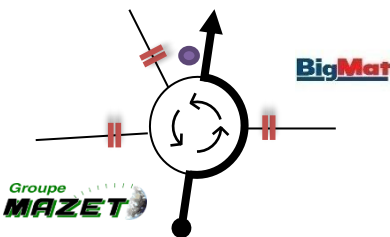
MONTSEGUR SUR LAUZON - MONTELMAR							
CH		DISTANCE	TEMPS		Section	Secteur	
DES 5	CH 5A	38,411	IMPARTI		2	9	
DES 8	CH 8A	MOYENNE	45'		3	14	
DES 11	CH 11A	48			4	19	
DISTANCES		DIRECTION		INFORMATIONS		DEGRESSIF	
TOTAL	PARTIEL						
4,717	1,223			PK 47	 	7	33,693
5,399	0,682			PK 53	 	8	33,011
5,869	0,470			PK 58	 S.R.P S.I	9	32,541
6,321	0,452			PK 63	 S.R.P S.I	10	32,089
7,040	0,719			PK 70	 S.R.P S.I	11	31,370
7,941	0,901			PK 79	 S.R.P S.I	12	30,469

MONTSEGUR SUR LAUZON - MONTELMAR						
CH		DISTANCE	TEMPS		Section	Secteur
DES 5	CH 5A	38,411	IMPARTI		2	9
DES 8	CH 8A	MOYENNE 48	45'		3	14
DES 11	CH 11A				4	19
DISTANCES		DIRECTION	INFORMATIONS			DEGRESSIF
TOTAL	PARTIEL					
8,892	0,951	  PK 88	D571 S.R.P S.I	13	29,518	
9,308	0,416	   PK 93	D471 CHANTEMERLE LES GRIGNAN	14	29,102	
11,289	1,981	  AES		15	27,121	
11,477	0,188	  STOP		16	26,933	
12,080	0,603	 	ZONE 30 MAS DES LAURELS CURLY DE PROVENCE	17	26,330	
12,958	0,878		ZONE 30 D549 MONTELMAR	18	25,452	

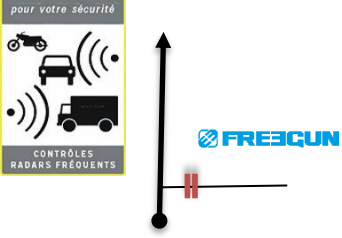
MONTSEGUR SUR LAUZON - MONTELIMAR						
CH		DISTANCE	TEMPS		Section	Secteur
DES 5	CH 5A	38,411	IMPARTI		2	9
DES 8	CH 8A	MOYENNE 48	45'		3	14
DES 11	CH 11A				4	19
DISTANCES		DIRECTION	INFORMATIONS			DEGRESSIF
TOTAL	PARTIEL					
14,700	1,742		19		23,710	
15,684	0,984		20		22,726	
16,753	1,069		21		21,657	
23,428	6,675		22		14,982	
23,863	0,435		23		14,547	
26,262	2,399		24		12,148	

MONTSEGUR SUR LAUZON - MONTELMAR						
CH	CH	DISTANCE	TEMPS		Section	Secteur
DES 5	CH 5A	38,411	IMPARTI		2	9
DES 8	CH 8A	MOYENNE	45'		3	14
DES 11	CH 11A	48			4	19
DISTANCES		DIRECTION	INFORMATIONS			DEGRESSIF
TOTAL	PARTIEL					
27,700	1,438		N7 S.R.P S.I			10,710
32,084	4,384		70 			6,326
33,103	1,019		70 D73 			5,307
33,686	0,583		70 N7  			4,724
34,496	0,810		50 N7   			3,914
34,992	0,496		N7 !! RADAR DOUBLE SENS !! 			3,418

COUPE DE FRANCE DES RALLYES PEA COEF. 3

FFSA

39EME RALLYE DU NOUGAT

DE MONTELMAR DROME PROVENCEALE

17EME VHC 14EME VHRS 4EME VMRS

ROAD-BOOK



DÉLÉSTAGE



29 ET 30 MAI 2026

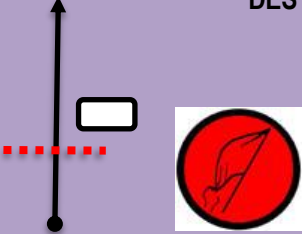

JP TACUSSEL - ALEYRAC

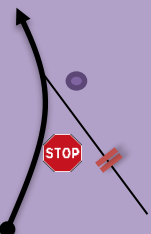
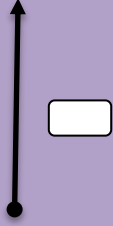
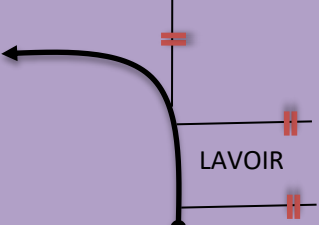
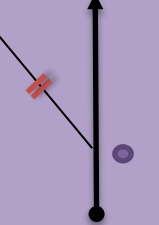
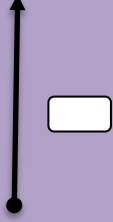

DES		CH	DISTANCE	TEMPS	Section	Secteur
ES 1			17,500	IMPARTI		
			MOYENNE XX	XX'		
DISTANCES		DIRECTION			INFORMATIONS	
TOTAL	PARTIEL				DEGRESSIF	
0,000	0,000					17,500
0,440	0,440				<p>D127</p> <p>LA TOUCHE LA BEGUDE DE M.</p>	17,060
1,200	0,760				<p>D127</p> <p>LA TOUCHE</p>	16,300
1,400	0,200				<p>S.R.P</p> <p>S.I</p>	16,100
1,600	0,200				<p>D127</p> <p>PORTES EN V. LA BEGUDE DE M.</p>	15,900
3,900	2,300				<p>PORTES EN VALDAINE</p>	13,600





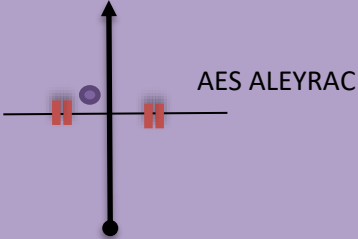

JP TACUSSEL - ALEYRAC

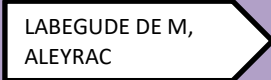

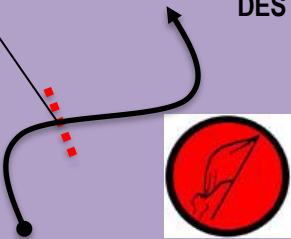

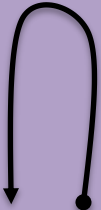
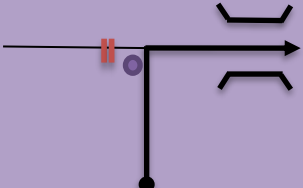
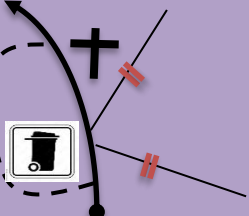
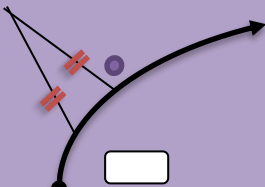
DES		CH	DISTANCE	TEMPS		Section	Secteur
ES 1			17,500	IMPARTI			
			MOYENNE	XX'			
DISTANCES		DIRECTION		INFORMATIONS		DEGRESSIF	
TOTAL	PARTIEL						
4,050	0,150	<p>BOULODROME</p>		<p>S.R.P</p> <p>S.I</p>		13,450	
4,150	0,100			<p>D127</p> <p>LA BEGUDE DE M.</p>		13,350	
6,350	2,200			<p>D9</p> <p>ALEYRAC</p>		11,150	
12,400	6,050	<p>AES 2</p>		<p>D9</p> <p>SALLE SOUS BOIS</p>		5,100	
17,500	5,100	<p>AES 1</p>		<p>REPRENDRE ROADBOOK PAGE 15</p> <p>CASE 15</p>		0,000	

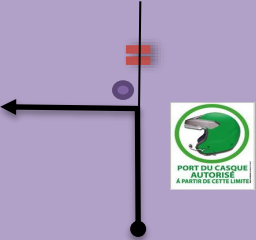
DELESTAGE ALEYRAC - PARC FERMEE





DES		CH	DISTANCE	TEMPS	Section	Secteur
ES 2			6,800	IMPARTI		
			MOYENNE XX	XX'		
DISTANCES		DIRECTION			INFORMATIONS	DEGRESSIF
TOTAL	PARTIEL					
0,000	0,000					6,8
0,000	0,000				FAIRE DEMI-TOUR	6,800
0,300	0,300				CHEMIN SAINT DENIS	6,500
0,750	0,450				S.R.P S.I	6,050
0,850	0,100				D24 ESPELUCHE MONTELIMAR SALLES SOUS BOIS	5,950
1,750	0,900	AES JP TACUSSEL 			D9 ALEYRAC	5,050

DELESTAGE ALEYRAC - PARC FERMEE							
DES	CH	DISTANCE	TEMPS		Section Secteur		
ES 2		6,800	IMPARTI				
		MOYENNE XX	XX'				
DISTANCES		DIRECTION			INFORMATIONS	DEGRESSIF	
TOTAL	PARTIEL				  REPRENDRE ROADBOOK PAGE 20 CASE 14		0,000
6,800	5,050						



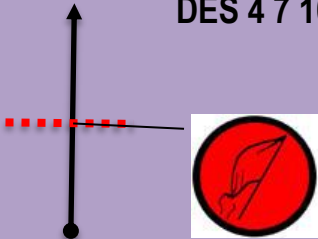

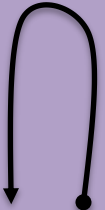
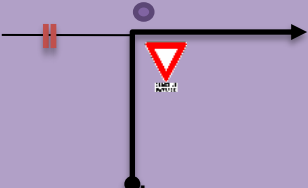
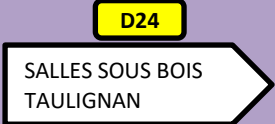
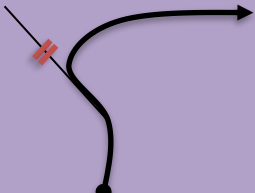

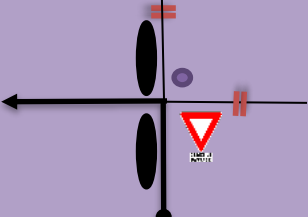
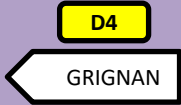

DELESTAGE ALEYRAC - LA CITELLE					
DES	CH	DISTANCE	TEMPS		Section Secteur
ES 3 6 9		1,850	IMPARTI		 PORT DU CASQUE INTERDIT A PARTIR DE CETTE LIMITE
		MOYENNE XX	XX'		
DISTANCES		DIRECTION	INFORMATIONS		DEGRESSIF
TOTAL	PARTIEL				
0,000	0,000	 DES 2			1,85
0,000	0,000		FAIRE DEMI-TOUR		1,850
0,300	0,300		CHEMIN SAINT DENIS		1,550
0,750	0,450		S.R.P S.I		1,100
0,850	0,100		D24 ESPELUCHE MONTELIMAR 		1,000
1,750	0,900	 	D24 ROCHEFORT EN V ESPELUCHE MONTELIMAR		0,100

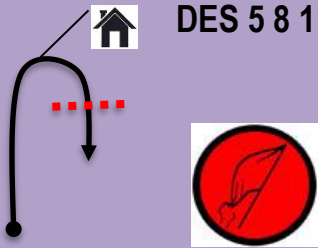
DELESTAGE ALEYRAC - LA CITELLE						
DES	CH	DISTANCE	TEMPS		Section Secteur	
ES 3 6 9		1,850	IMPARTI		 PORT DU CASQUE INTERDIT A PARTIR DE CETTE LIMITE	
		MOYENNE XX	XX'			
DISTANCES		DIRECTION			INFORMATIONS	DEGRESSIF
TOTAL	PARTIEL					
1,850	0,100	  				0,000

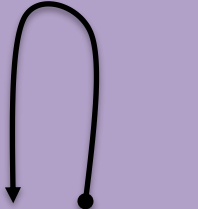
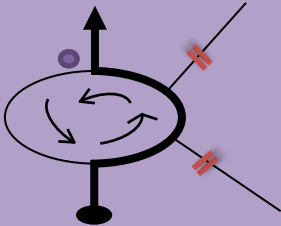

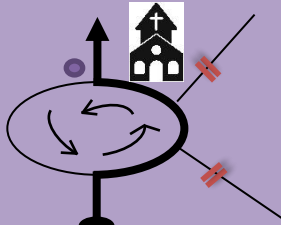
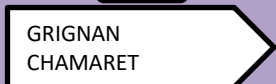
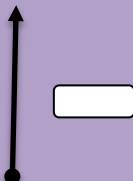

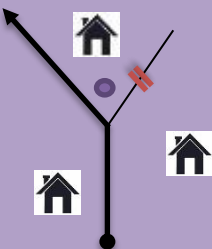

DELESTAGE LA CITELLE - BASSIN DES DRUIDES

DES		CH	DISTANCE	TEMPS	Section	Secteur
ES 4 7 10			4,000	IMPARTI		
			MOYENNE XX	XX'		
DISTANCES		DIRECTION			INFORMATIONS	
TOTAL	PARTIEL				DEGRESSIF	
0,000	0,000					
0,000	0,000				<p>FAIRE DEMI-TOUR</p>	
0,000	0,000					
0,900	0,900					
4,000	3,100				 <p>REPRENDRE ROADBOOK PAGE 38 CASE 13</p>	

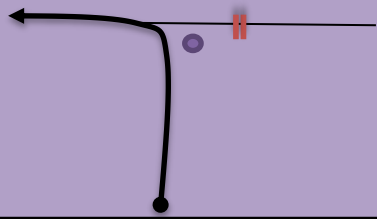
DELESTAGE BASSIN DES DRUIDES - PARC FERMEE

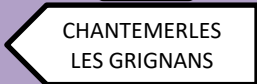
CH		CH		DISTANCE	TEMPS	Section	Secteur
ES 5 8 11		11,500		MOYENNE	IMPARTI		
		XX		XX'			
DISTANCES		DIRECTION		INFORMATIONS			DEGRESSIF
TOTAL	PARTIEL						
0,000	0,000						11,500
0,000	0,000			<p>FAIRE DEMI-TOUR</p>			11,500
0,800	0,800	<p>CENTRE MEDICAL</p> 		<p>D71</p> <p>GRIGNAN VALREAS</p> 			10,700
1,200	0,400			<p>D71</p> <p>GRIGNAN CHAMARET</p> 			10,300
5,300	4,100			<p>D71</p> <p>CHAMARET</p> 			6,200
5,500	0,200			<p>D471</p> <p>CHANTEMERLES LES GRIGNANS</p> 			6,000

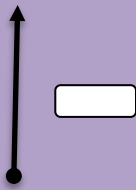
DELESTAGE BASSIN DES DRUIDES - PARC FERMEE

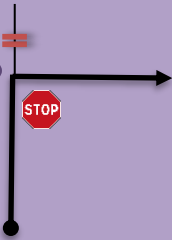
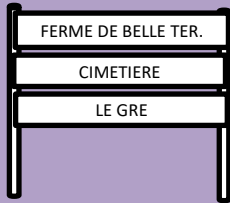
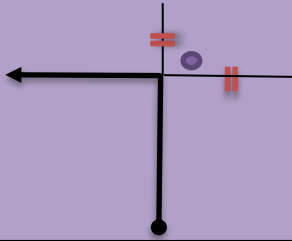
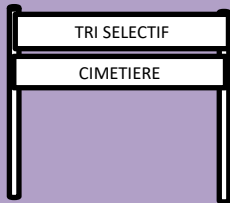
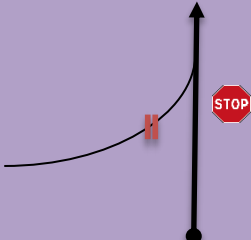
CH		CH		DISTANCE	TEMPS	Section	Secteur
ES 5 8 11				11,500	IMPARTI		
				MOYENNE	XX'		
DISTANCES		DIRECTION		INFORMATIONS		DEGRESSIF	
TOTAL	PARTIEL						
7,600	2,100			 		3,900	
9,200	1,600			S.R.P S.I		2,300	
9,700	0,500					1,800	
9,800	0,100					1,700	
10,150	0,350					1,350	
11,500	1,350			REPRENDRE ROADBOOK PAGE 43 CASE 18		0,000	